

ADNART INTRODUCES

"SUPER PACK"!



ADNART IS NOW OFFERING 100% SAFE PROTECTIVE PACKAGING TO INSURE ABSOLUTELY NO BREAKAGE ON YOUR CERAMIC MUG ORDERS.

A SMALL PRICE TO PAY FOR PEACE OF MIND AND NO BREAKAGE ISSUE!

**PRICE: 6.20 (G)/CASE
(36 UNIT CASE)**

ADNART WILL GUARANTEE 100% AGAINST ANY BREAKAGE ONLY BY USING THE "SUPER PACK" CARTONS!



NEW ITEMS



FRESH N GO	4-7
PUMP N CHILL	8-9
OASIS WATER BOTTLE	10-11
VIVA WATER BOTTLE	12-13
LA CANAL WATER BOTTLE	14-15
SKINNY MINI	16-17
WHITE COLLECTION	18-19
NU-WAVE WATER BOTTLE	64-65
LA TOUR WATER BOTTLE/LEA MIE	66-67



TEA TIME MUG SET	106-107
GRATE N TOP	108-109
QUARTETTO ESPRESSO SET	110-111
CAFE POUR OVER MUG	118-119
RETRO VIBE CUP	122-123
RUBY MUG	128-129
EMERALD BOWL	130-131
LA MIE DU PAIN	140-141
PARADISO FRUIT PETITES	142-143
ALL DAY SUPER OATS	144-145



WINE AND BEER

"VIN BLANC" WINE CHILLER	20-21
FROSTY BEER 2 GO	22-23
MOSCOW MULE	49
IMPERIAL COFFEE & WINE	50-51
GROWLER 2 GO	52-53
MIGHTY GROWLER	54
PINT GLASS OPENER	56
BREW CUP OPENER	57
E-FLASK	73
VINO OPENER	74
CHILL VINO	75
VINO 2 GO	76
STACK N GO VINO	77
VINO TINI	78



COFFEE, TEA AND HOT BEVERAGES

"LE BATON" TRAVEL BOTTLE	24-25
BIG BOSS JUMBO TUMBLER	32-33
THE GLADIATOR TUMBLER	34-35
LIBERTY CANTEEN	36-37
MANHATTAN COFFEE TUMBLER	42
5TH AVENUE COFFEE TUMBLER	43
DIVA TRAVEL MUG	44
I CAN COFFEE CUP	45
CAFE LATTE TUMBLER	46
HAPPY TRAILS TUMBLER	47
HAPPY CAMPER MUG	48
SIMPLY CLEAR	79
ICE T 2 GO	80-81
TW2N LIDS & ESCAPE BOTTLE	82-83
BUMPER	84
DOUBLE & SINGLE GLASS BOTTLE	85
FLAVOUR IT	86-87
FLAVOUR IT 2 GO (2 VERSIONS)	88-89
MASION JAR	90
GLASS MASION JAR	91
SILI-SQUEEZE (2 VERSIONS)	94
FOLDABLE WATER (2 VERSIONS)	95
TEA BALL	102
PRESS CAFE	103
HOT PRESS & MODERN PRESS	104-105
GRATE N TOP	108-109

TEA TIME MUG SET	106-107
HOLIDAY TEA GIFT SETS	114-115
ASOBU TEA PRODUCTS	116-117
TEA PARTY & MY T GIFT SETS	118-119
TEA TIME GIFT SET	120-121



SPORT AND WATER BOTTLES

OASIS WATER BOTTLE	10-11
VIVA WATER BOTTLE	12-13
LA CANAL WATER BOTTLE	14-15
SKINNY MINI	16-17
CENTRAL PARK TRAVEL BOTTLE	26-29
TIME SQUARE TRAVEL BOTTLE	30-31
ALPINE FLASK	38-39
MIGHTY FLASK	40-41
SHAKE IT BABY WORK OUT	55
THE JUICY DRINK BOX	58-59
NATURE'S WAY	62-63
NU-WAVE WATER BOTTLE	64-65
LA TOUR WATER BOTTLE	66-67
PINNACLE SPORTS BOTTLE	68
TRIOPH SPORTS BOTTLE	69
PILL BOTTLE	70
SAMBA SHAKER	72
DEEP FREEZE BOTTLE	96
PERMA FROST	97
STAINLESS STEEL BOTTLES	98-99
SPORTS WATER BOTTLE	100
TURBO SPORT BOTTLE	101



CERAMIC PORCELAIN BONE CHINA MUGS

CAFE POUR OVER MUG	122-123
HAPPY TRAIL CERAMIC	124-125
RETRO VIBE CUP	126-127
RUBY MUG	128-129
EMERALD BOWL	130-131
WHITE QUARTZ MUG	132-133
HOT CHOCOLATE & SET	134-135
PORCELAIN JEWEL	136
IVORY TOWER	137
PORCELAIN SAPHIRE	138
CHOCOLATE SET	139
SPARKLING MUG	146
ESPRESSO GIFT SET	110-111
NATURE'S GARDEN MUG & SET	112-113



THE PEARL	148-149
THE BLACK PEARL	150-151
PRECIOUS STONEWARE	152
BLACK ONYX MUG	153
GOOD MORNING MUG	154
COASTER MUG SET	155
"ROCK OF GIBRALTAR" MUG	154
CHALK BOARD MUG	157
DOUBLE WALL MUGS WITH LIDS	158
THERMO STEEL	159
COUNTRY STYLE MUG	160
HOUR GLASS MUG	161
BIG GULP MUG	162
TWO TONE MUG	163
TRIM TONE MUG	164
FUNNEL MUG	165
WESTERN MUG	166
C HANDLE MUG	167
JUMBO C HANDLE MUG	168
SWEET & COOZY MUG	169
CHOCO OHOLIC CAKE	169

HEALTHY LIFESTYLE

FRENCH N GO	4-5
PUMP N CHILL	6-7
CHILL YO 2 GO	60-61
YO 2 GO	92-93
LA MIE DU PAIN	140-141
PARADISO FRUIT PETITES	142-143
ALL DAY SUPER OATS	144-145



GLASSWARE

SCOTCH TASTER GLASS	170
WHITE ICE & ICE BALL	171
CHAMPAGNE & WINE	172-173
BEER & PILSNER	174-175
STEMLESS WINE & SHOOTERS	176-177
BEVERAGE & COFFEE GLASSES	179
MARTINI GLASSES	180
ELEGANCE DECANTER	181
CANDY JARS	182

PACKAGING OPTIONS

COASTERS	183
PACKAGING OPTIONS	184-185

INDEX	186
TERMS AND CONDITIONS	187

PATENTED PENDING
NEW!

The best SOLUTION
KEEPS BEVERAGE
Fresh
& NUTRITIOUS.



FRESH n GO!

SMOOTHIE AND JUICE TUMBLER

THE BEST SOLUTION TO KEEP YOUR BEVERAGE FRESH AND NUTRITIOUS

The patented and unique smoothie tumbler has features like no other!
It is the best solution to keep your beverage fresh and nutritious. The air pump removes oxygen from your smoothie or juice and protects it from oxidizing and decomposing. The vacuum insulation and double wall stainless steel will keep your drink chilled up to 24 hours!
The "FRESH N GO" supports a healthy lifestyle and helps you enjoy quality nutrition. It literally lets you capture the best nature can provide, extends freshness, slows oxidation and prolongs nutrient life.
"FRESH N GO" has a 17oz / 500ml capacities, is 100% BPA free and leak proof. It comes with a reusable straw and recipe booklet is also included.
Just blend your favourite smoothie or fresh juice. Pour it into the wide mouth opening, then pump the air out and enjoy!

FEATURE

- Vacuum insulated / dual copper plated insulation
- Double wall stainless steel
- 17z / 500ml capacity
- 100% BPA free
- Dishwasher safe
- Stays cold up to 24 hours

Keeps your smoothie chilled for hours.

Blend
YOUR FAVOURITE SMOOTHIE OR JUICE
Pour into
WIDE MOUTH CUP
Close lid
TIGHTLY
Pump
AIR OUT

AND
Enjoy



COLOUR OPTIONS: ● ● ● ● ● ●

ITEM#: FNG1

17OZ/ 500ML
IMPRINT AREA: 3"H X3"W
WRAPAROUND: 8"

ITEM NO.	72	144	288	SET-UP	REPEAT SET-UP
FNG1	24.99	23.99	22.99	65.00	50.00
2ND COLOUR:	1.65(C)				5C

- PRICE INCLUDES:
- 1 TUMBLER
 - 1 STRAW
 - 1 MIXING BALL
 - 1 COLOUR IMPRINT AND GIFT BOX



PATENTED PENDING
NEW!

FRESHnGO!

Prolongs
NUTRIENT
CONSERVATION
Slows
OXIDATION
Extends
FRESHNESS
& TASTE

*Smoothie
& juice*
TUMBLER

Supports
HEALTHY LIFESTYLE
Enjoy
QUALITY NUTRITION
Capture
THE BEST NATURE
CAN PROVIDE



PATENTED PENDING
NEW!

The best SOLUTION
KEEPS BEVERAGE
Fresh
& NUTRITIOUS.



Smoothie
& Juice
TUMBLER

FRESHnGO!
PUMP N CHILL
SMOOTHIE AND JUICE TUMBLER

THE BEST SOLUTION TO KEEP YOUR BEVERAGE FRESH AND NUTRITIOUS

The "Pump n Chill" smoothie tumbler can be frozen over and over and will keep your drink chilled for hours, even on a hot summer day! Simply insert the bottle into the freezer for a minimum of 1 hour or more and you will have a chilled beverage at your disposal all day.

The air pump removes oxygen from your smoothie or freshly squeezed juice and protects it from decomposing and oxidizing. The gel double wall will keep your drink chilled up to 12 hours!

The "Pump n Chill" supports a healthy lifestyle and helps you enjoy quality nutrition. It literally lets you capture the best nature can provide, extends freshness, slows oxidation and prolongs nutrient life.

"Pump n Chill" has a 15oz / 470ml capacities, is 100% BPA free and leak proof. It comes with a reusable straw and recipe booklet is also included.

Just blend your favourite smoothie or fresh juice. Pour it into the wide mouth opening, then pump the air out and enjoy!

FEATURE

- Double wall gel insulation
- 15oz / 470ml capacity
- 100% BPA free
- Dishwasher safe
- Stays cold up to 12 hours



ITEM#: FNG2

15OZ/470ML
IMPRINT AREA: 3"H X3"W
WRAPAROUND: 8"

ITEM NO.	72	144	504	SET-UP	REPEAT SET-UP
FNG2	23.99	22.99	19.99	65.00	50.00
2ND COLOUR:	1.65(C)			5C	

- PRICE INCLUDES:
- 1 TUMBLER
 - 1 STRAW
 - 1 MIXING BALL
 - 1 COLOUR IMPRINT AND GIFT BOX

COLOUR OPTIONS: ● ● ● ● ●



PATENT PENDING

NEW!



"OASIS" WATER BOTTLE

THE FASHION FORWARD "OASIS" LINE OF BOTTLES

The fashion forward "OASIS" line of bottle is a "must have" accessory! Complement your look with these highly practical bottles with trendy colors.

The OASIS has a 20 oz/ 600ml capacity, is vacuum insulated, double wall stainless steel, which will stay cool up to 24 hours! The leak proof lid and easy grip texture make it a practical travel companion. OASIS is the accessory you need to get soon!

FEATURE

- Vacuum insulated / dual copper plated insulation
- Double wall stainless steel
- 20oz / 600ml capacity
- 100% BPA free
- Dishwasher safe
- Stays cold up to 24 hours

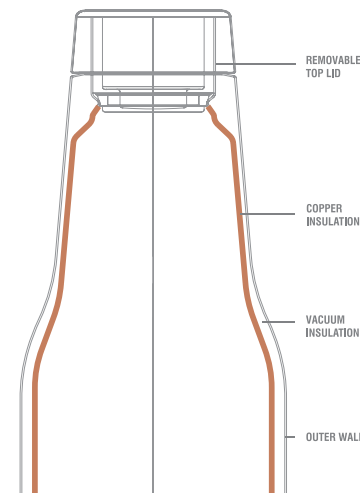

COLOUR OPTIONS: ○ ● ● ● ● ●

ITEM#: SBV23

20OZ/ 600ML
IMPRINT AREA: 3"H X3"W
WRAPAROUND: 8"

ITEM NO.	72	144	288	SET-UP	REPEAT SET-UP
SBV23	19.99	18.99	17.99	65.00	50.00
2ND COLOUR: 1.65(C)				5C	

PRICE INCLUDES: - 1 BOTTLE
- 1 COLOUR IMPRINT AND GIFT BOX



WHITE GRAY BLACK PEACH LIME TURQUOISE GIFT BOX

PATENT PENDING

NEW!



“VIVA LA VIE” WATER BOTTLE

ENJOY YOUR LIFE, AND REMEMBER A DIFFERENT PERSPECTIVE CAN CHANGE EVERYTHING!

A Celebrate life with the “VIVA LA VIE” travel bottle at your side!
It features a shock resistant insulating acrylic exterior and stainless steel inner chamber. This creates an insulated zone that will keep your drink hot up to 6 hours or cold up to 12 hours. The unique look lets you stand out in the crowd!

FEATURE

- Acrylic exterior
- 18/8 stainless steel interior
- Screw top leak proof lid
- Detachable and very easy to clean
- 18oz / 540ml capacity
- 100% BPA free
- Dishwasher safe
- Keeps your drink cool for hours



COLOUR OPTIONS:

ITEM#: SP04

18OZ/ 525ML
IMPRINT AREA: 3”H X3”W
WRAPAROUND: 8”

ITEM NO.	75	150	500	SET-UP	REPEAT SET-UP
SP04	17.99	16.99	15.99	65.00	50.00
2ND COLOUR: 1.65(C)				5C	

PRICE INCLUDES: - 1 BOTTLE
- 1 COLOUR IMPRINT AND GIFT BOX



ORANGE BLUE TEAL BURNT COPPER BLACK GIFT BOX

NEW!



LE CANAL WATER BOTTLE

TAKE "LE CANAL". IT IS THE LONG SCENIC ROUTE AND THE STYLISH WAY TO TRAVEL.

"LE CANAL" Bottle features an ergonomic easy access grip that makes it an ideal "on the go" travel tumbler. The rubberized exterior makes it very comfortable to drink from! The vacuum insulated dual copper stainless steel double wall construction will stay cool for up to 24 hours and hot up to 12 hours.

The slender design slides effortlessly into purses, backpacks and carry on luggage. You need to get one soon!

FEATURE

- Vacuum insulated / dual copper plated insulation
- Double wall stainless steel
- easy ergonomic grip lid
- 100% BPA free
- Dishwasher proof
- Rubberized exterior finish

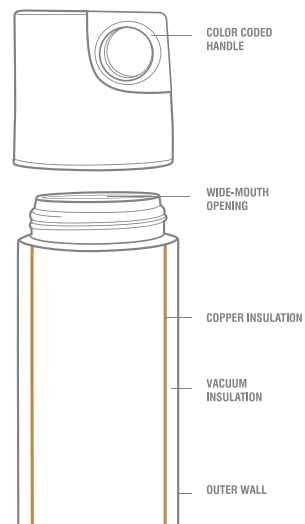

ITEM#: SBV19

16OZ/ 480ML
IMPRINT AREA: 3"H X3"W
WRAPAROUND: 8"

ITEM NO.	72	144	504	SET-UP	REPEAT SET-UP
SBV19	19.99	18.99	17.99	65.00	50.00
2ND COLOUR:	1.65(C)			5C	

PRICE INCLUDES: - 1 BOTTLE
- 1 COLOUR IMPRINT AND GIFT BOX

COLOUR OPTIONS: ● ● ● ● ●



NEW!



SKINNY MINI WATER BOTTLE

"SKINNY MINI" IS THE ONLY FASHION CHIC ACCESSORY YOU NEED!

It fits in your back pocket, your purse. It is easy to grip, comes with built in carry strap and it holds 10 oz of your favourite beverage. Will stay cool for up to 12 hours, hot for 6 hours!

FEATURE

- 8oz/230ml capacity
- Vacuum insulated / dual copper plated insulation
- Double wall stainless steel
- Easy grip lid, built in carry strap
- Compact / easy to carry
- Stays cold up to 12 hours, hot up to 6 hours
- 100% BPA free
- Dishwasher proof

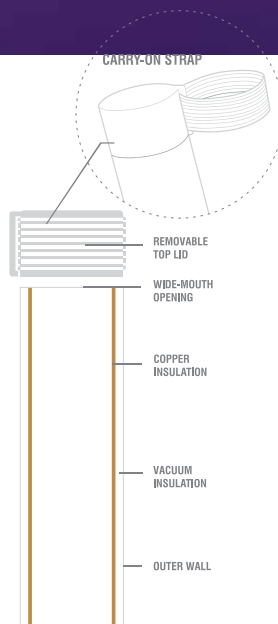

COLOUR OPTIONS: ● ● ● ●

ITEM#: SBV20

8OZ/ 230ML
 IMPRINT AREA: 3"H X3"W
 WRAPAROUND: 8"

ITEM NO.	60	120	240	SET-UP	REPEAT SET-UP
SBV20	14.99	13.99	12.99	65.00	50.00
2ND COLOUR:	1.65(C)			5C	

PRICE INCLUDES: - 1 BOTTLE
 - 1 COLOUR IMPRINT AND GIFT BOX



NEW!



BLINDED by THE
WHITE

BLINDED BY THE WHITE!

Blinded by the white! Simple yet elegant, what a fashion statement! The sleek rubberized matte finish makes it soft and yet firm to the touch. Upgrade your look today.



“VIN BLANC” PORTABLE WINE CHILLER

ELEGANT AND PRACTICAL THE #1 CHOICE OF WINE ENTHUSIASTS

The Vin Blanc Portable Wine Chiller is the ONLY wine chiller that you will ever need! This ingenious chiller is practical, safe and lightweight; it IS the ideal product for transporting and keeping fine wine at the recommended temperature.

The long awaited Vin Blanc Portable Wine Chiller appeals to wine enthusiasts everywhere! The vacuum insulated, double wall stainless steel construction insures your wine remains cool for up to 24 hours. The cushioned interior protects the wine bottle from breakage during transportation. The elegant carrying case has a convenient carry strap built into the cushioned lid.

A practical silicone wine stopper completes this innovative chiller; opened bottles can be carried safely and trouble free.

The Vin Blanc Portable Wine Chiller is the ONLY stylish solution to transporting and chilling your favourite wine. Settle for nothing less, wine should constantly be enjoyed at the correct temperature!

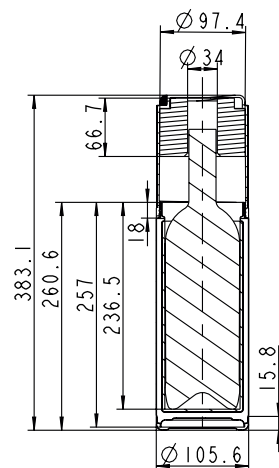

ITEM#: VPB1

IMPRINT AREA: 4.5"H X3"W
WRAPAROUND: 8"

ITEM NO.	72	144	288	SET-UP	REPEAT SET-UP
VPB1	42.65	41.58	39.50	65.00	50.00
2ND COLOUR:	1.65(C)			5C	

PRICE INCLUDES: -1 WINE CHILLER
-1 COLOUR IMPRINT
- GIFT BOX

COLOUR OPTIONS: ● ●



SILVER BLACK GIFT BOX



FROSTY BEER 2 GO

THE FROSTY BEER BOTTLE ALWAYS RECEIVES A WARM RECEPTION!

The beer lover inspired Frosty Beer 2 go is the ultimate "cool tool" to keep your favourite bottle of beer frosty cold!

Vacuum insulated, double wall stainless steel technology insures that your favourite bottled beer will remain frosty cold regardless of the outside temperature.

All North American domestic beer bottles, Central / South America, Caribbean, European and Australian beers fit in the Frosty Beer 2 Go. Including the popular Corona! Beer cans are also welcome!

Say goodbye to drinking another lukewarm beer! Whatever the event, your beer will always remain cold. The Frosty Beer 2 go comes equipped with a bottle opener! Yes, we thought of everything! No more searching for that missing opener, it is built right into this handy tool!

The Frosty Beer 2 go you need to get one soon! Beer should always be enjoyed chilled!

ITEM#: FC2G

IMPRINT AREA: 2.5"H X 2.5"W
WRAPAROUND: 8"

ITEM NO.	48	144	288	SET-UP	REPEAT SET-UP
FC2G	23.45	22.50	21.50	65.00	50.00
2ND COLOUR:	1.65(C)			5C	

PRICE INCLUDES: -1 FC2GO (INCLUDING 2 BEER OPENER)
-1 COLOUR IMPRINT
- SLEEVE



BLACK SILVER

COLOUR OPTIONS: ● ●

PATENT PENDING



NEW!



LE BATON TRAVEL BOTTLE

THE ULTIMATE FASHION FORWARD BOTTLE

The stylish "Le Baton" Travel Bottle keeps beverages cold for up to 24 hours and hot up to 12 hours. The slender design of this trendy bottle makes it the perfect travel companion, slides effortlessly into laptop bags, carry-on luggage and backpacks. The stunning matte finish, complete with stylish lid makes it a must for all fashion enthusiasts. It truly is creative drinkware at its best!

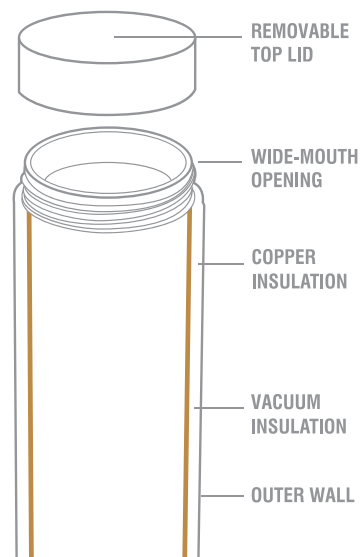

ITEM#: LB17

17OZ/ 500ML
IMPRINT AREA: 4"H X3.5"W
WRAPAROUND: 8"

ITEM NO.	72	144	288	SET-UP	REPEAT SET-UP
LB17	19.18	18.65	18.12	65.00	50.00
2ND COLOUR:	1.65(C)				5C

PRICE INCLUDES: - 1 BOTTLE
- 1 COLOUR IMPRINT AND GIFT BOX

COLOUR OPTIONS:



NEW!



CENTRAL PARK BOTTLE

MODERN, PRACTICAL AND ECO FRIENDLY...THAT'S OUR MESSAGE!

We are now introducing the new "tone on tone" fashion look. This exciting design takes your bottle to a whole new level as a fashion accessory!

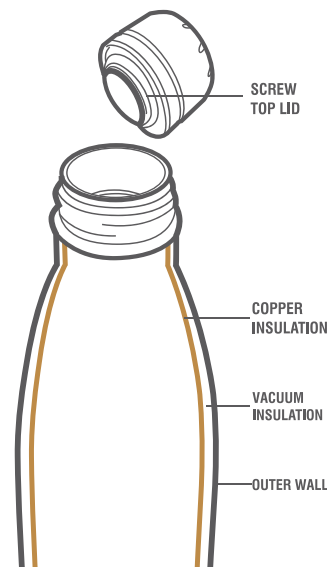

ITEM#: SBV17

17(OZ) / 510(ML)
IMPRINT AREA: 3"H X 2"W
WRAPAROUND: 7.5"W

ITEM NO.	72	144	288	SET-UP	REPEAT SET-UP
SBV17	20.25	19.73	19.18	65.00	50.00
2ND COLOUR:	1.65(C)			5C	

PRICE INCLUDES: - 1 BOTTLE
- 1 COLOUR IMPRINT
- GIFT BOX

COLOUR OPTIONS:



BLACK/BLACK



WHITE/SILVER



GIFT BOX



PREMIER PACKAGING UNDECORATED ADD: 4.78(C)

NEW!



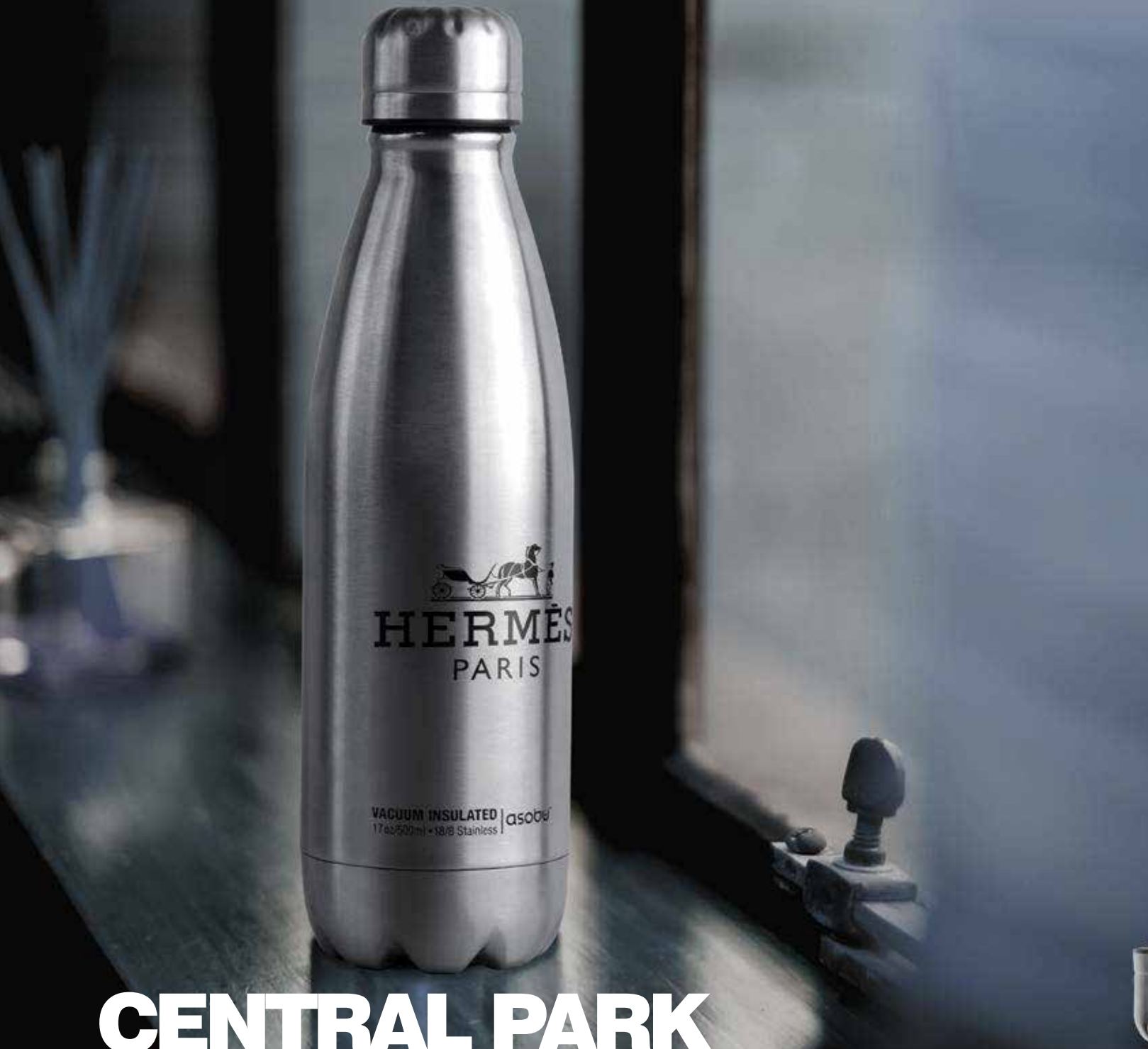

CENTRAL PARK BOTTLE

MODERN, PRACTICAL AND ECO FRIENDLY...THAT'S OUR MESSAGE!

The Central Park is one of the most innovative travel bottles on the market today! This fashion forward bottle's sleek design and large capacity makes it a must for work, travel and school.

The robust 18/8 stainless steel structure is virtually indestructible!

This Vacuum sealed double wall bottle will remain hot for up to 12 hours and cool for 24 hours!

The easy access spill proof lid and stunning matte finish create a product that embraces fashion and functionality. 100% BPA free this eco friend product is a must for all ages

Make heads turn with this eye-catching travel bottle, a walk in the park never felt so good.....

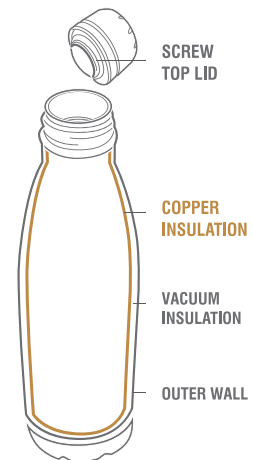

ITEM#: SBV 17

17(OZ) / 510(ML)
 IMPRINT AREA: 3"H X 2"W
 WRAPAROUND: 7.5"W

ITEM NO.	72	144	288	SET-UP	REPEAT SET-UP
SBV17	20.25	19.73	19.18	65.00	50.00
2ND COLOUR: 1.65(C)				5C	

PRICE INCLUDES: - 1 BOTTLE
 - 1 COLOUR IMPRINT
 - GIFT BOX

COLOUR OPTIONS:



BLACK/SILVER BLACK/COPPER COPPER/SILVER SILVER GOLD/SILVER GIFT BOX PREMIER PACKAGING UNDECORATED ADD 4.78(C)

PATENT PENDING



TIMES SQUARE TRAVEL BOTTLE

SLEEK, STYLISH AND ATTENTION-GRABBING

The Times Square Travel Bottle is the ultimate travel companion. Style, durability and a sleek matte finish make this eye-catching hydration bottle stand out in a crowd! Slides neatly in your carry-on luggage, backpack, and standard vehicle cup holders. The sturdy double wall, vacuum insulated stainless steel construction insures that your drink remains cold for up to 24 hours, and hot for up to 12 hours. Dishwasher proof and available in the latest stylish matte finish this sturdy 18/8 stainless steel bottle is made to last a lifetime!

Make a statement at the office, in class and commuting to work with this first class travel bottle!

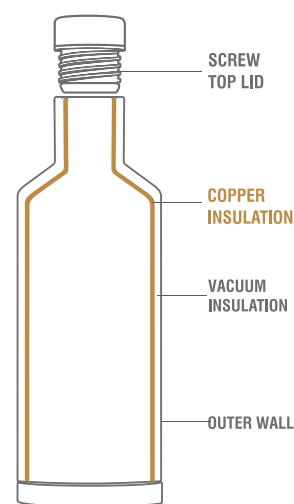

ITEM#: SBV15

15(OZ) / 450(ML)
 IMPRINT AREA: 3"H X 2.5"W
 WRAPAROUND: 8"

ITEM NO.	72	144	288	SET-UP	REPEAT SET-UP
SVB15	21.47	20.28	17.29	65.00	50.00
2ND COLOUR:	1.65(C)			5C	

PRICE INCLUDES: - 1 BOTTLE
 - 1 COLOUR IMPRINT
 - GIFT BOX

COLOUR OPTIONS: ● ● ● ● ●



PREMIER PACKAGING UNDECORATED ADD 4.78(C)



NEW!

BIG BOSS JUMBO TUMBLER

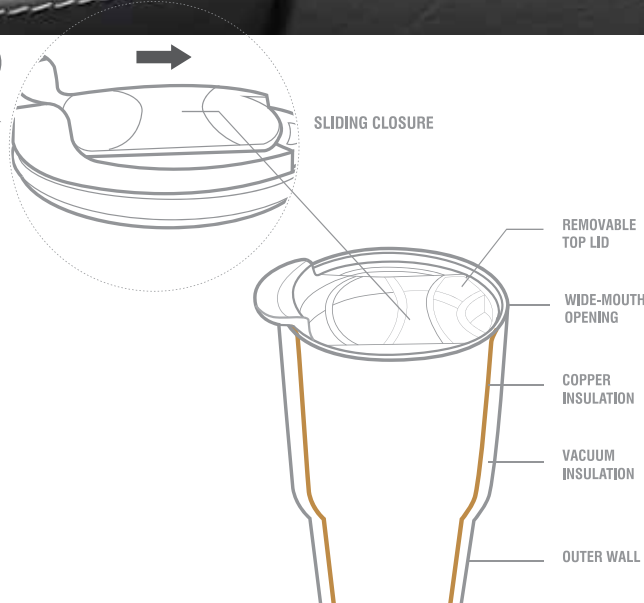

30 OUNCES TO POWER YOUR DAY

- 18/8 stainless steel construction
- Vacuum insulation technology
- Push-on plastic lid with slide tab opening
- Sleek and ergonomic design
- Edgy matte black or satin steel finish

HOT FOR UP TO 12 HOURS
COLD FOR UP TO 24 HOURS

100% BPA Free

Our largest travel mug is easy to carry and also fits in a car cupholder

COLOUR OPTIONS:

ITEM#: BF30

30(OZ) / 900(ML)
IMPRINT AREA: 2.75"H X 3.5"W
WRAPAROUND: 9"W

ITEM NO.	48	144	288	SET-UP	REPEAT SET-UP
BF30	25.90	24.90	23.90	65.00	50.00
2ND COLOUR:	1.65(C)			5C	

PRICE INCLUDES: - 1 TUMBLER
- 1 COLOUR IMPRINT
- GIFT BOX





THE GLADIATOR TUMBLER

STRONG, DEPENDABLE AND ALWAYS BY YOUR SIDE

The Gladiator Tumbler is the newest addition to our Lifetime Warranty series. This sturdy vacuum insulated, double wall 18/8 stainless steel tumbler will keep your drink hot for up to 12 hours and cool up to 24 hours! A transparent spill proof adjustable lid completes this modern on the go tumbler. The stunning matte finish gives the Gladiator Tumbler a superior feel; with a large 20 oz/600 ml capacity it is the ultimate tumbler. Grab one for the office, school and car.

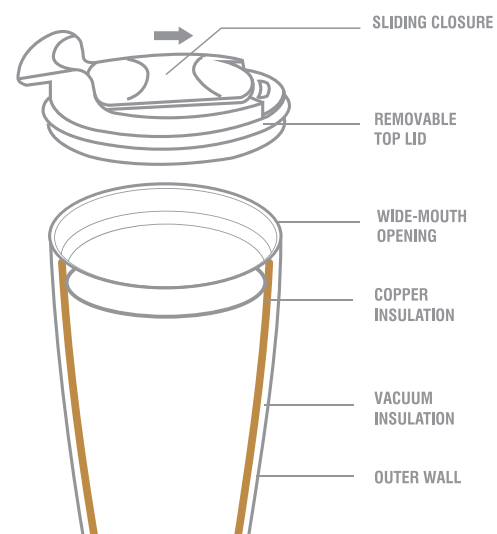

NEW!

COLOUR OPTIONS:

ITEM#: BF20

20 (OZ)/600 ML
 IMPRINT AREA: 2.5"H X 2.5"W
 WRAPAROUND: 7"

ITEM NO.	48	144	288	SET-UP	REPEAT SET-UP
BF20	25.90	24.90	23.90	65.00	50.00
2ND COLOUR:	1.65(C)			5C	

PRICE INCLUDES: - 1 TUMBLER
 - 1 COLOUR IMPRINT
 - GIFT BOX



PATENT PENDING

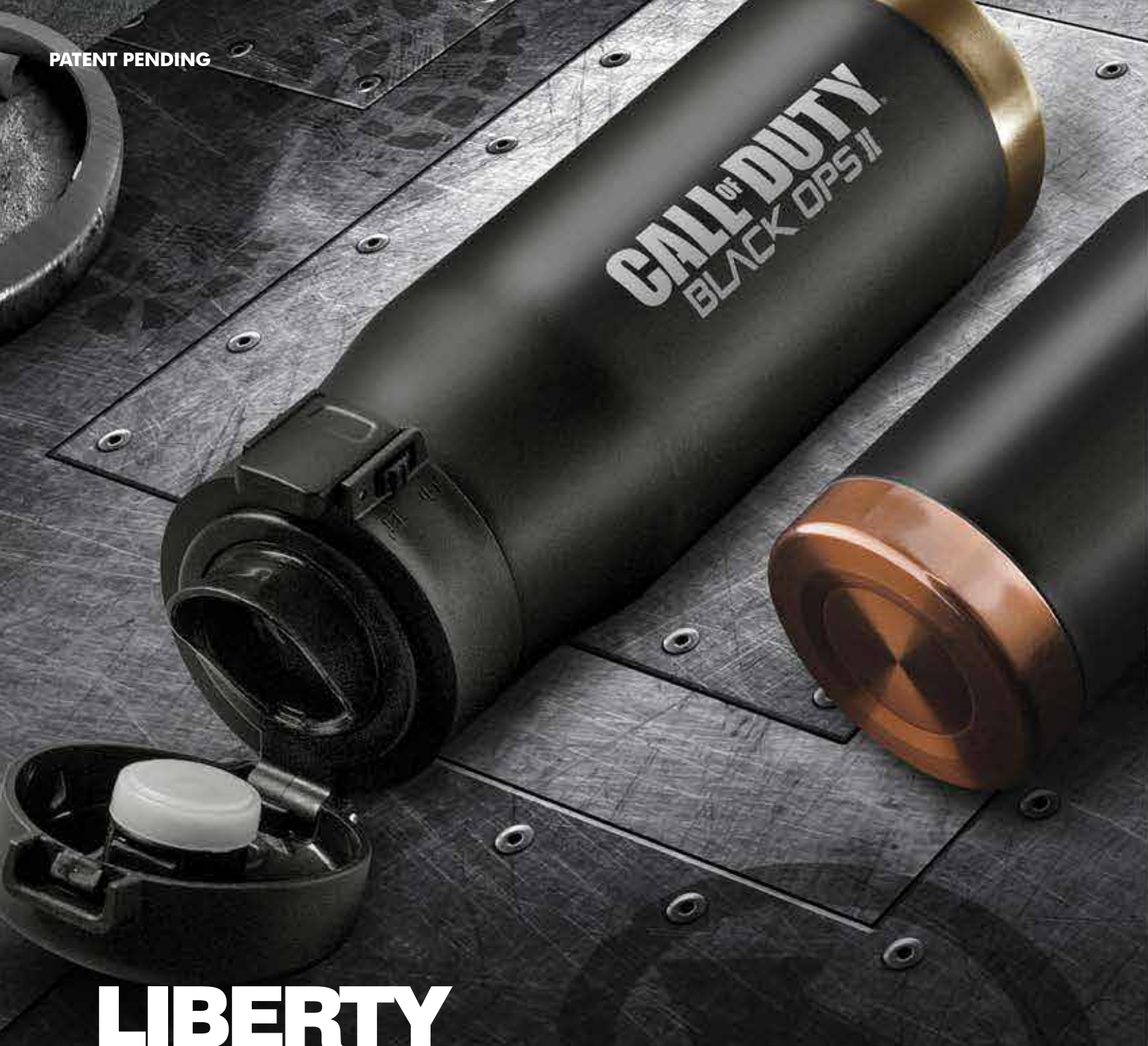

LIBERTY CANTEEN

All boundaries are broken with this incredible travel mug! The Liberty Canteen has no limits. It boasts all the latest features and style. The striking matte finish and distinctive design makes this canteen the most sought after drinkware product on the market! Virtually indestructible the Liberty Canteen will stand up to the most rigorous use.

Double wall, vacuum insulated technology keeps your drink cold for up to 24 hours and piping hot for up to 12 hours! The easy access durable flip top lid maintains spill proof protection. Fill up the Liberty Canteen and experience the independence of the ultimate on the go canteen.

Holds 17 oz/ 500 ml and comes with a Lifetime Warranty it is the most sort after canteen on the market!

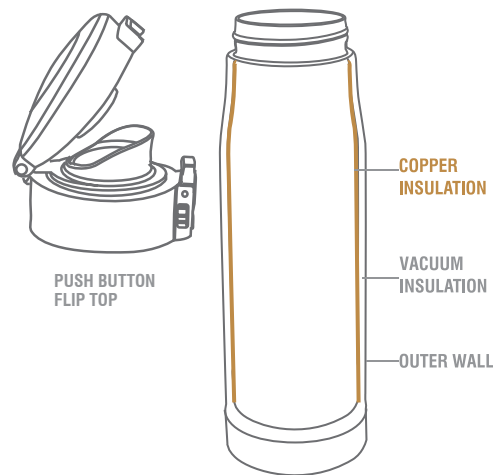

ITEM#: LC17

17(OZ) / 500(ML)
IMPRINT AREA: 3" H X 3" W
WRAP AROUND: 7.5" W

ITEM NO.	72	144	288	SET-UP	REPEAT SET-UP
LC17	19.18	18.65	18.12	65.00	50.00
2ND COLOUR:	1.65(C)			5C	

PRICE INCLUDES: - 1 TRAVEL CANTEEN
- 1 COLOUR IMPRINT
- GIFT BOX

COLOUR OPTIONS:



SILVER COPPER NICKLE GOLD GIFT BOX



For coffee or sports drinks

ALPINE FLASK

18OZ INDESTRUCTIBLE FLASK

High quality 18/8 stainless steel construction
 Vacuum insulation technology
 Easy screw insulated lid with carrying loop
 Anti-slip exterior coating
 Wide opening, easy to fill and clean

HOT for up to 12 hours,
 COLD for up to 24 hours

100% BPA free, 100% recyclable

Fits in a backpack or in your car

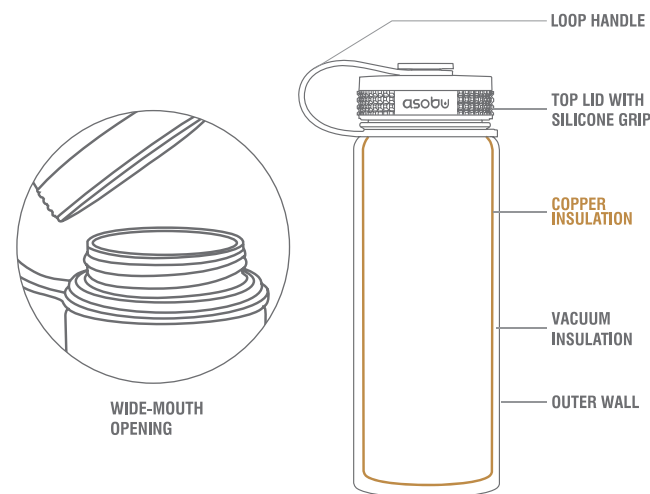

COLOUR OPTIONS: ● ○ ● ● ●

ITEM#: TMF2

18(OZ) / 530(ML)
 IMPRINT AREA: 4"H X 3"W
 WRAPAROUND: 8"W

ITEM NO.	48	144	288	SET-UP	REPEAT SET-UP
TMF2	19.90	18.90	17.90	65.00	50.00
2ND COLOUR:	1.65(C)				5C

PRICE INCLUDES: - 1 BOTTLE
 - 1 COLOUR IMPRINT
 - GIFT BOX





the
MIGHTY
FLASK

40 OUNCE THERMAL CARAFE

Why bring unsafe and bulky glass bottles to the house party, beach or tailgate event, when you can show up with this safe, elegant, 40 ounce stainless steel mighty flask storage bottle / growler.

- stays hot up to 12 hours. Stays cool up to 24 hours
- Hot beverage, coffee, tea
- Thermal carafe
- Sport drinks hydration
- Wide mouth opening, double wall vacuum insulated
- Reusable and 100% BPA Free

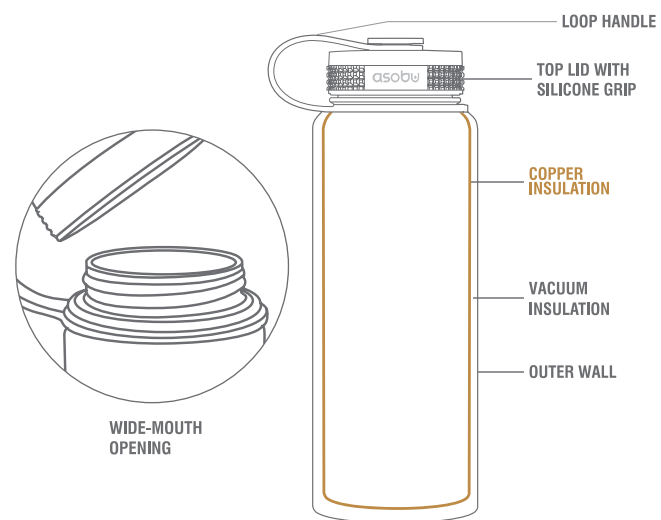

ITEM#: TMF1

40(OZ)/1.1(L)
IMPRINT AREA: 5" H X 3" W
WRAPAROUND : 11" W

ITEM NO.	48	72	240	SET-UP	REPEAT SET-UP
TMF1	31.34	29.10	26.86	65.00	50.00
	2ND COLOUR: 1.65(C)				5C

PRICE INCLUDES: - 1 BOTTLE
- 1 COLOUR IMPRINT
- SLEEVE & GIFT BOX

COLOUR OPTIONS: ● ● ○ ● ●



BLACK RED WHITE BLUE BROWN



MANHATTAN COFFEE TUMBLER

DOUBLE WALL VACUUM INSULATED

18/8 stainless steel construction, Vacuum insulation technology, Lid has spill-proof snap lock tab, Easy screw lid, Satin finish exterior

HOT for up to 12 hours, COLD for up to 24 hours

Sleek and ergonomic design

ITEM#: V700

17(OZ) / 500(ML)
IMPRINT AREA: 3" H X 3" W
WRAPAROUND: 7.5" W

ITEM NO.	48	72	144	288	SET-UP	REPEAT SET-UP	PRICE INCLUDES:
V700	15.66	15.10	14.54	13.98	65.00	50.00	- 1 TUMBLER - 1 COLOUR IMPRINT - GIFT BOX
2ND COLOUR:	1.65(C)					6C	

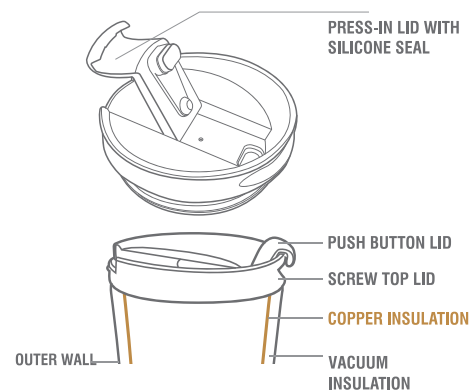

5 AVENUE COFFEE TUMBLER

EASY GRIP TEXTURED EXTERIOR FINISH

18/8 stainless steel construction, Vacuum insulation technology, Push button flow Leak proof easy screw lid, Matte exterior finish, Easy match color options

HOT for 6 hours, COLD for up to 24 hours

Cool-off rim avoids direct contact of hot beverage with lips

ITEM#: V800

13(OZ) / 390(ML)
IMPRINT AREA: 2.5" H X 4" W
WRAPAROUND: 7.5" W

ITEM NO.	48	72	144	288	SET-UP	REPEAT SET-UP	PRICE INCLUDES:
V800	16.78	16.22	16.00	15.66	65.00	50.00	- 1 TUMBLER - 1 COLOUR IMPRINT - GIFT BOX
2ND COLOUR:	1.65(C)					6C	

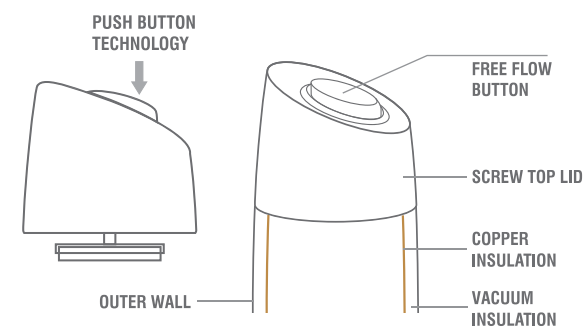



the **DIVA**
TRAVEL MUG

INSULATED BOTTLE WITH LOCKING LID

Vacuum insulation technology
Locking lid makes it spill-proof
Satin finish exterior
Lid opens softly
hot up to 12 hours, cold up to 24 hours

100% BPA free
Dishwasher safe

High quality bottle, with flip open lid and soft color options

ITEM#: V600

15(OZ)/450(ML)
IMPRINT AREA: 2.5"H X 2.5"W
WRAPAROUND: 7.5"

ITEM NO.	75	150	500	SET-UP	REPEAT SET-UP
V600	19.70	18.46	17.34	65.00	50.00
2ND COLOUR:	1.65(C)			5C	

PRICE INCLUDES:

- 1 "DIVA" BEVERAGE CONTAINER
- 1 COLOUR IMPRINT
- GIFT BOX



PREMIER
PACKAGING
UNDECORATED
ADD 4.78(C)

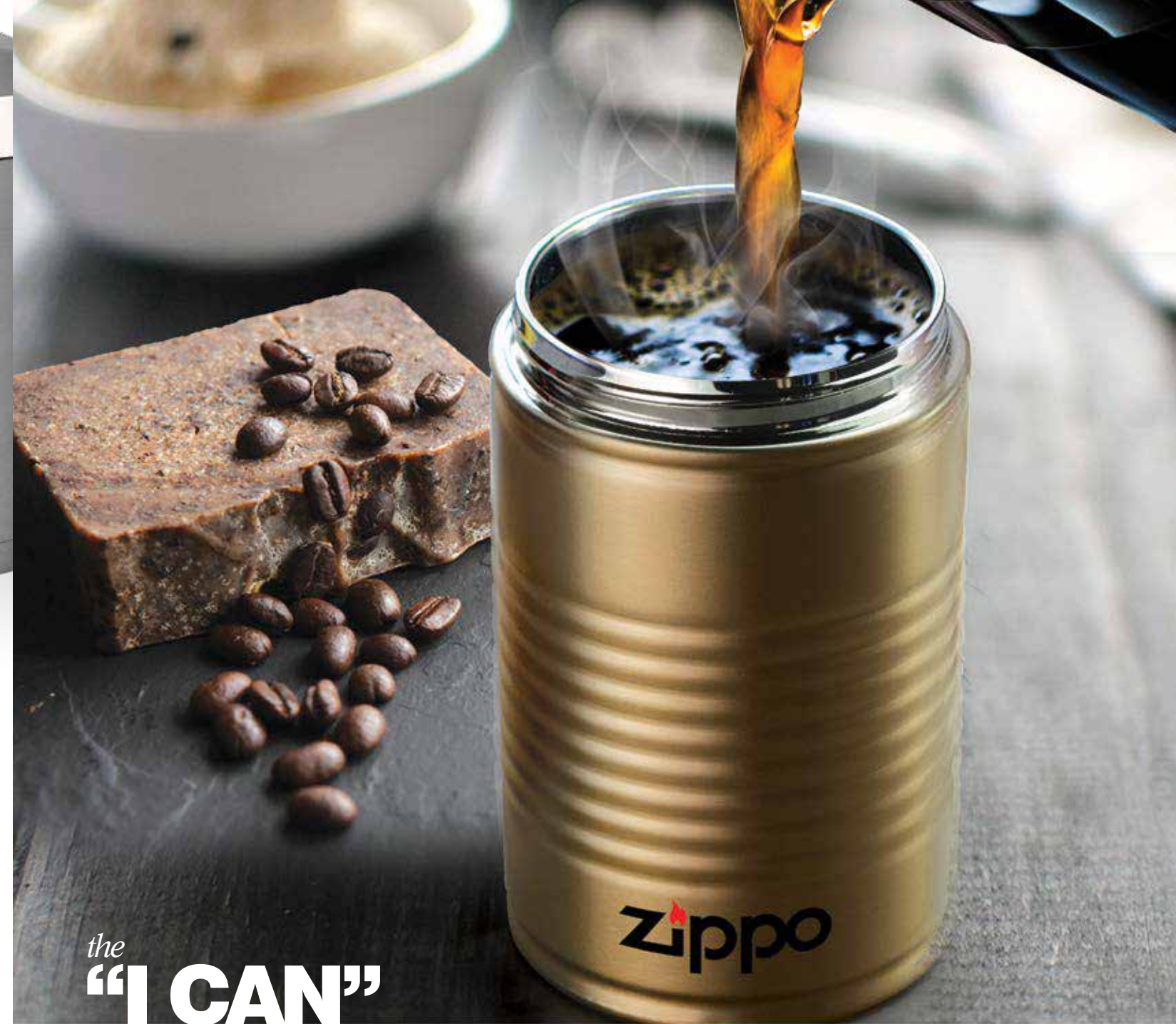

the **"I CAN"**
COFFEE CUP

"STEAL" ONE TODAY!

This stainless steel twist on the traditional coffee mug is the fresh new way to serve up your favourite beverage!

This 18 oz double walled stainless steel ICAN is the perfect match for that hot cup of coffee at work, home or backyard! Your favourite beverage keeps hot in this stainless steel 'mug' and will not chip or break like china or porcelain.

This eco friendly, completely recyclable ICAN is undeniably out with the old and in with the new!

ITEM#: IC17

18(OZ) / 540(ML)
IMPRINT AREA: 1"H X 2"W
WRAPAROUND" 7"

ITEM NO.	72	144	504	SET-UP	REPEAT SET-UP
IC17	10.65	9.58	8.52	65.00	50.00
2ND COLOUR:	1.65(C)			5C	

PRICE INCLUDES:

- 1 CUP
- 1 COLOUR IMPRINT



COLOUR OPTIONS: ● ● ● ● ●



CAFÉ LATTE TUMBLER

COLOUR OPTIONS: ● ● ○ ● ●

FILL & GO – THE ECO FRIENDLY WAY

Enjoy a hot or cold beverage in the new Café Latte Tumbler. This striking double wall stainless tumbler with easy access lid will keep your drink hot or cold for hours! Fill with your favourite beverage on your daily commute to your local café and do your part for the environment!

Enjoy at work, school, and in the car. Fits all standard vehicle cup holders, comes in five eye-catching colors. Help the environment by even filling up your favourite café!

ITEM#: LCC16

16(OZ) / 480(ML)
IMPRINT AREA: 2.5"H X 2.5"W
WRAPAROUND: 8"

ITEM NO.	72	144	504	SET-UP	REPEAT SET-UP
LCC16	15.98	14.92	13.85	65.00	50.00
2ND COLOUR: 1.65(C)				5C	

PRICE INCLUDES:

- 1 TUMBLER
- 1 COLOUR IMPRINT
- GIFT BOX



SILVER BLACK WHITE RED BLUE PACKAGING



HAPPY TRAILS TUMBLER

COLOUR OPTIONS: ● ● ● ● ○

RETRO MEETS CLASSIC!

This handy designer tumbler is made of top quality enamel coated stainless steel. Available in a large capacity of 16 oz/500 ml this stylish tumbler is ideal for drinking your favourite beverage in a casual setting, whether you are in the country or relaxing in the heart of the city the Happy Trails Tumbler is perfect for any occasion.

Enjoy the look and feel of this fashionable product while camping, relaxing by the pool or at a backyard BBQ.

Stackable and virtually indestructible the Happy Trails Tumbler is the ultimate retro tumbler!

ITEM#: HT16

16(OZ) / 500(ML)
IMPRINT AREA: 2.5"H X 2.5"W

ITEM NO.	72	144	504	SET-UP	REPEAT SET-UP
HT16	10.65	9.58	8.52	65.00	50.00
2ND COLOUR: 1.65(C)				5C	

PRICE INCLUDES:

- 1 TUMBLER
- 1 COLOUR IMPRINT



BLACK RED BLUE GREEN WHITE

HAPPY CAMPER mug

COTTAGE STYLE ENAMEL MUG

Get this classic mug. Used by campers, even famous explorers. Enjoy the country ambiance while drinking your tea or coffee.

Be a happy camper, get this for your office now!

ITEM#: CFM15

16 OZ / 480 ML
IMPRINT AREA: 1.75"H X 2.5"W
WRAPAROUND: 8.5"W

ITEM NO.	48	144	504	SET-UP	REPEAT SET-UP
CFM15	10.06	9.52	8.94	65.00	50.00
2ND COLOUR:	0.89(C)			5C	

PRICE INCLUDES:
- 1 ENAMEL FINISH MUG
- 1 COLOUR IMPRINT



WHITE GREEN RED COBALT BLACK

COLOUR OPTIONS: ● ● ● ● ●

MOSCOW MULE copper mug

PREMIUM COPPER PLATED MUG

Stainless steel construction
Rich copper-hued exterior
High polish exterior finish
Stylish angled handle

100% BPA free
Hand wash only
Perfect for icy cold cocktails or beer

MOSCOW MULE RECIPE:

- Fill mug with ice
- Add 2oz vodka, 1/2 oz lime juice
- 5 oz ginger beer
- Sprig of mint

ITEM#: CMM 14

20(OZ)/600(ML)
IMPRINT AREA: 1.5"H X 2"W
WRAPAROUND: 5.5"

ITEM NO.	72	144	504	SET-UP	REPEAT SET-UP
CMM14	20.14	19.58	19.02	65.00	50.00
2ND COLOUR:	0.89(C)			5C	

PRICE INCLUDES:
- 1 MOSCOW MULE MUG
- 1 COLOUR IMPRINT
- GIFT BOX



PACKAGING

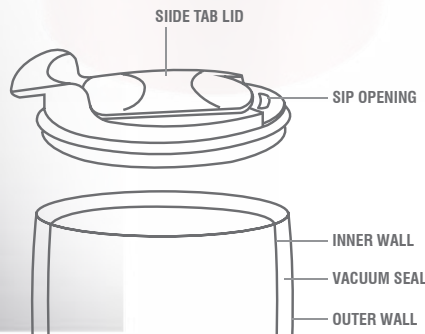

COLOUR OPTIONS: ● ● ● ● ●

IMPERIAL BEVERAGE

HOT ON THE INSIDE, COOL ON THE OUTSIDE !

18/8 stainless steel construction
 Vacuum insulation technology
 Clear lid with slide tab opening
 Silky matte exterior finish

100% BPA free
 Dishwasher safe

A stylish thermal cup, ready to grace any office or boardroom meeting with style

Available in five rich jewel tones

ITEM#: VIC3

10(OZ)/300(ML)
 IMPRINT AREA: 2"H X 2"W
 WRAPAROUND: 7"

ITEM NO.	50	150	500	SET-UP	REPEAT SET-UP
VIC3	16.78	15.66	14.54	65.00	50.00
2ND COLOUR: 1.65(C)				5C	

PRICE INCLUDES:
 - 1 CUP WITH LID
 - 1 COLOUR IMPRINT
 - GIFT BOX

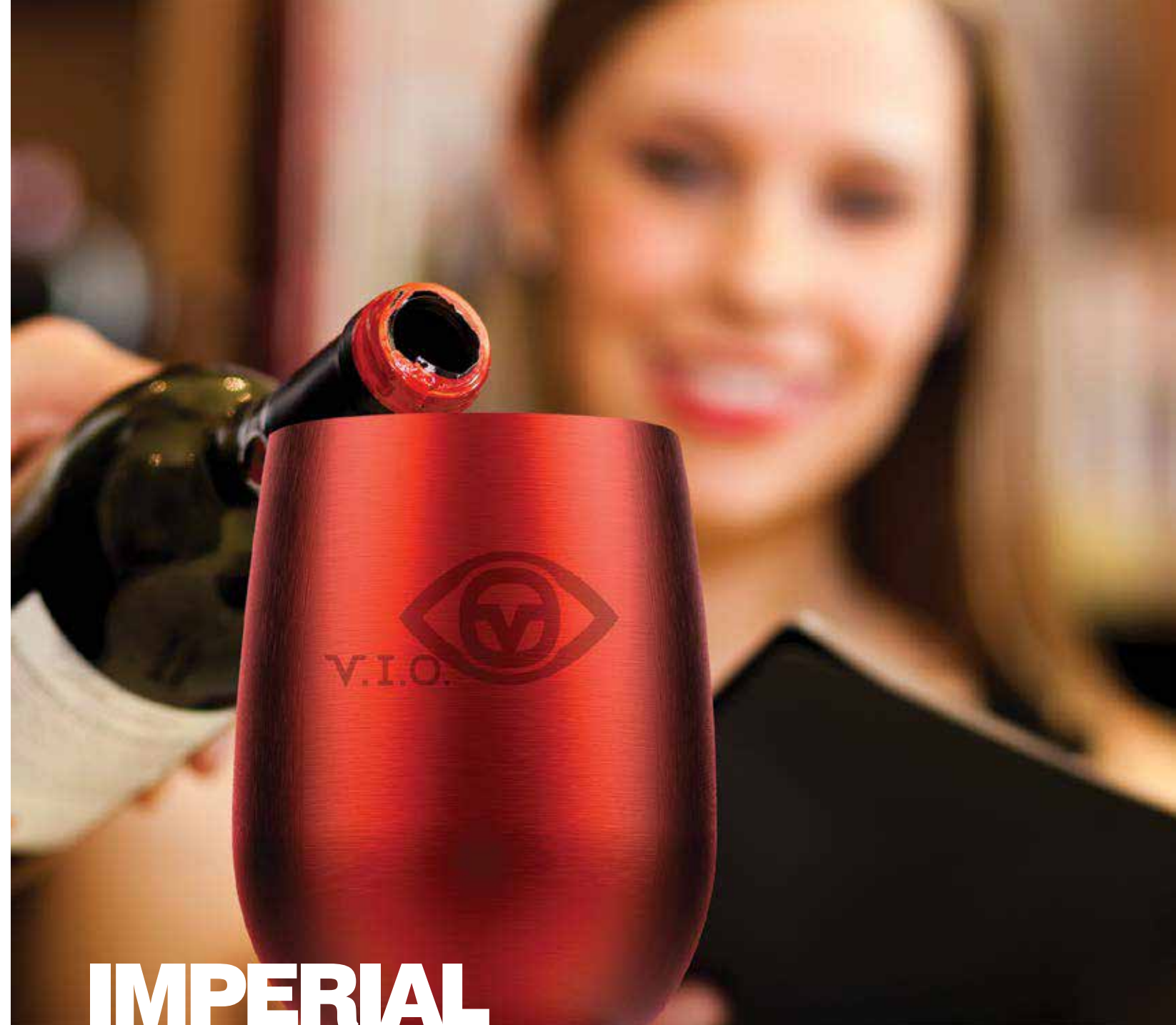

IMPERIAL WINE

COLOUR OPTIONS: ● ● ● ● ●

ELEGANT THERMAL CUP IS IDEAL FOR WINE ENTHUSIASTS!

18/8 stainless steel construction
 Vacuum insulation technology
 Silky matte exterior finish

100% BPA free
 Dishwasher safe

The Imperial serves the dual purpose of an attractive stemless cup, while keeping wine at the correct temperature

Available in five rich jewel tones

ITEM#: VIW 1

9(OZ)/270(ML)
 IMPRINT AREA: 2"H X 2"W
 WRAPAROUND: 7"

ITEM NO.	50	150	500	SET-UP	REPEAT SET-UP
VIW1	16.78	15.66	14.54	65.00	50.00
2ND COLOUR: 1.65(C)				5C	

PRICE INCLUDES:
 - 1 CUP
 - 1 COLOUR IMPRINT
 - GIFT BOX



NEW!

Neoprene insulating sleeve to keep your beer cooler for longer. Comes with a carrying strap



GROWLER 2 GO

64 OUNCE RUSTIC STYLE BEER CONTAINER

18/8 stainless steel construction
Swing top locking lid keeps beer fresh
Narrow neck and spout prevents spillage
Refillable with home brew, seasonal beer, import draught on tap, etc...
Transport beer safely to any event
Easy to clean

This growler lets you take your favorite craft beer to parties, the cottage or the beach.

Neoprene sleeve available for extra charge of \$12(c)



Total height 11.25" h

ITEM#: G2G

64(OZ)/1.9(L)
IMPRINT AREA : 3"H X 3"W
WRAPAROUND : 7.75"W

ITEM NO.	24	48	96	SET-UP	REPEAT SET-UP
G2G	31.34	29.1	27.98	65.00	50.00
2ND COLOUR:	1.65(C)			5C	

PRICE INCLUDES:
- 1 BOTTLE
- 1 COLOUR IMPRINT
- 1 HANG TAG WITH CARE INSTRUCTIONS

COLOUR OPTIONS: ● ● ● ● ●



AMBER SILVER COPPER BLACK HANG TAG



PATENT PENDING



THE MIGHTY GROWLER

GREAT BEER DESERVES THE MIGHTY GROWLER

This elegant growler is fitted with an advanced air tight lid which maintains full carbonation, keeping the beer fresh and cool. The wide mouth easy access and refill feature makes the Mighty Growler the ideal growler for the micro-brew lover. 18/8 food grade stainless steel is the safe and secure alternative to glass. The growler comes complete with a carry strap for ease of transportation.

Enjoy your favourite brew in style with the Mighty Growler!

ITEM#: G4G

64(OZ)/1.1(L)
IMPRINT AREA: 3"H X3"W
WRAPAROUND: 9"

ITEM NO.	24	48	144	SET-UP	REPEAT SET-UP
G4G	47.76	46.57	45.38	65.00	50.00
2ND COLOUR:	1.65(C)			5C	

PRICE INCLUDES:
- 1 GROWLWE
- 1 COLOUR IMPRINT
- 1 HANG TAG



Neoprene sleeve available for extra charge of \$12(c)



SILVER BLACK HANG TAG



SHAKE IT BABY WORK OUT BOTTLE

SHAKE UP YOUR WORKOUT ROUTINE!

The Shake it Baby Work Out Bottle

Design practicality and ease of use make this innovative bottle the perfect workout companion. Measure markings engraved into the rugged exterior stainless steel wall ensure an accurate mix of products. The easy access spout with spill resistant locking cap guarantees that your shakes stay fresh with zero leakage. Durable blades fitted into the lid mix your protein or hydration mix, PLUS to maximise complete mix ability 2 free flow blending balls bounce around while you are on the go!

ITEM#: SSB25

30(OZ) / 900(ML)
IMPRINT AREA: 3"H X 3"W
WRAPAROUND: 7.5"W

ITEM NO.	72	144	288	SET-UP	REPEAT SET-UP
SSB25	10.65	10.12	9.58	65.00	50.00
2ND COLOUR:	1.65(C)			5C	

PRICE INCLUDES:

- 1 BOTTLE
- 2 SHAKER BALLS
- 1 COLOUR IMPRINT
- GIFT BOX



BLACK RED GREEN BLUE

COLOUR OPTIONS: ● ● ● ●



PINT GLASS OPENER



COLOUR OPTIONS: ● ● ● ●

BEER GLASS WITH INTEGRATED DUAL OPENER

Heavy duty clear glass with stainless steel base
Dual opener capability – twist open and snap off
Satin finish stainless steel base

100% BPA free
Dishwasher safe

Ad N Art developed the dual opener for it's two beer cup models and ever since, this practical concept's popularity has grown. Our beer cups are a winning product year after year.

ITEM#: BO 2

18.5(OZ)/550(ML)
IMPRINT AREA: 3"H X 2.5"W
WRAPAROUND: 7.75"W

ITEM NO.	72	144	504	SET-UP	REPEAT SET-UP
BO2	13.42	12.3	11.18	65.00	50.00
2ND COLOUR: 1.65(C) UPGRADE TO DEEP ETCH 4.50(C)				5C	

PRICE INCLUDES:
- 1 PINT GLASS OPENER CUP
- 1 COLOUR IMPRINT
- GIFT BOX



BREW CUP OPENER

Snap off lids
Twist open lids

COLOUR OPTIONS: ● ● ● ●

BEER CUP WITH INTEGRATED DUAL OPENER

Stainless steel construction
Dual opener capability – twist open and snap off
Satin finish exterior
Lightweight, Stackable

100% BPA free
Dishwasher safe

Classy and safe beer cups for parties, camping, poolside or beach

Match your team colors with the four jewel tone options

ITEM#: BO 1

18.5(OZ)/550(ML)
IMPRINT AREA: 2.5"H X 2.5"W
WRAPAROUND: 8"

ITEM NO.	72	144	504	SET-UP	REPEAT SET-UP
BO1	13.42	12.3	11.18	65.00	50.00
2ND COLOUR: 1.65(C)				5C	

PRICE INCLUDES:
- 1 BREW OPEN CUP
- 1 COLOUR IMPRINT
- GIFT BOX





THE JUICY DRINK BOX

COLOUR OPTIONS:

IT'S TIME TO THINK OUTSIDE THE BOX!

The Juicy Drink Box is the ultimate on the go item! Refillable, recyclable and cost efficient this environmentally friendly juice box is perfect for school, picnics and BBQs. Made from virtually indestructible shock resistant Tritan, this freezable, scratch resistant, and 100% BPA free juice box is both dishwasher and food grade safe. Two re-usable food grade silicone straws complete this must have juice box. Purchase the indispensable Juicy Drink Box and help contribute to a greener world!

Pick from six fruit inspired colours.
Capacity - 10 oz. /290ml

INSTRUCTIONS:

- 1 TO OPEN**
Slide handle to the right.
- 2 TO CLOSE:**
Slide handle to the left and tuck straw into place.

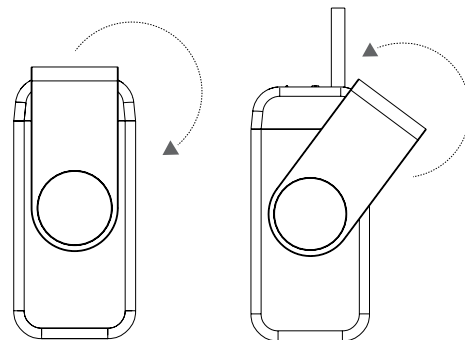

ITEM#: JB300

10(OZ) / 290(ML)
IMPRINT AREA: 1.25"D

ITEM NO.	75	150	500	SET-UP	REPEAT SET-UP
JB300	11.72	11.18	10.65	65.00	50.00
2ND COLOUR:	1.65(C)				5C

PRICE INCLUDES:

- 1 BOTTLE
- 1 COLOUR IMPRINT
- INSTRUCTION SLEEVE



WHITE BLUE GREEN YELLOW RED PURPLE

PATENT PENDING

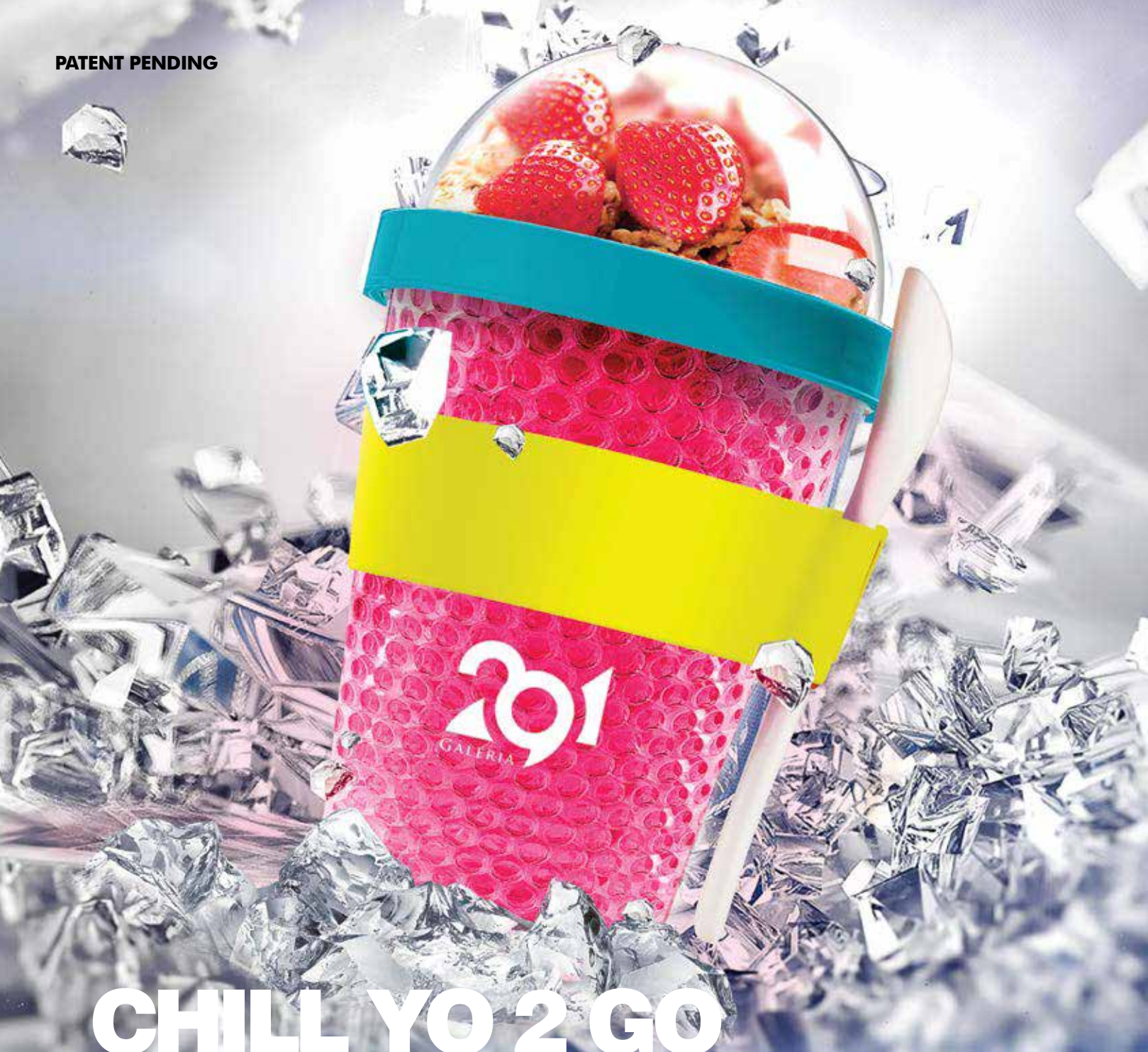

CHILL YO 2 GO

COLOUR OPTIONS: ●●●●●●●

ON THE GO SNACKS NEVER LOOKED SO COOL!

This creative addition to the Yo 2 Go line has a built in double wall of freezable honeycomb non toxic gel.

This innovative gel freezes in only one hour, resulting in the contents of the Chill Yo 2 Go remaining chilled for hours, even on a hot sunny day! Fruit, nuts, cereal and other toppings stay fresh, while your yogurt, frozen yogurt and even ice cream will remain chilled for hours! Make a smoothie, relax; enjoy your creative snack in the Chill Yo 2 Go. It is ready when you are! It is the ultimate addition to your on the go lunch.

Available in a wide variety of trendy colours, this go to product comes with a sturdy melamine spoon and matching silicone grip band.

The Chill Yo 2 Go is the perfect solution to adding a healthy bite to your day. At school, work or play it is a must for all ages!

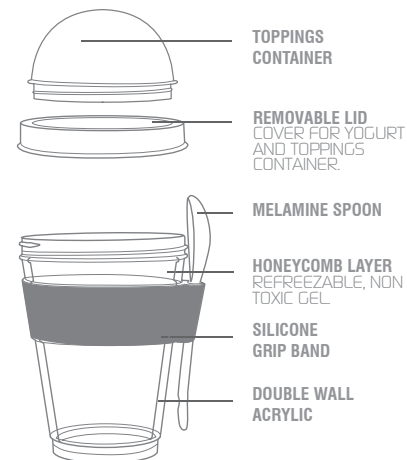

ITEM#: CY2GO

13(OZ) / 386(ML)
IMPRINT AREA: 2"H X2"W

ITEM NO.	72	144	504	SET-UP	REPEAT SET-UP
CY2GO	13.85	12.78	11.72	65.00	50.00
2ND COLOUR:	1.65(C)				5C

PRICE INCLUDES:
- 1 CHILL YO 2 GO
- 1 COLOUR IMPRINT
- GIFT BOX





NATURE'S WAY GLASS BOTTLE

NATURE AT ITS BEST

The Nature's Way Glass Bottle is the glass lover's hydration bottle. Style, practicality and safety are the qualities of this eco friendly glass bottle. The fashion forward Nature's Way Glass Bottle boasts a wide mouth opening for easy fill, the spill proof lid and handy carrying strap make it a hit with nature lovers everywhere!

A colourful easy grip protective sleeve keeps the glass bottle safe and sound while on the go. Fits in all standard vehicle travel cup holders

Choose from a wide variety of stylish pastel colors. Ideal for the office, school and backyard.

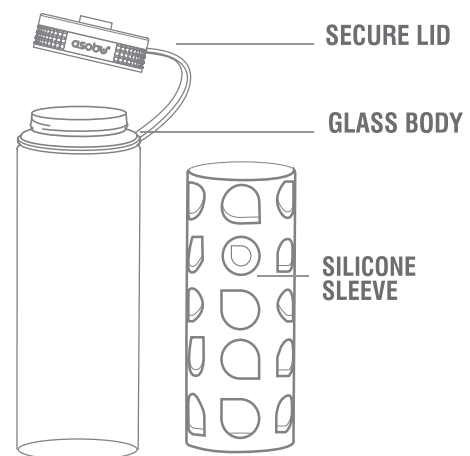

COLOUR OPTIONS: ○ ● ● ● ●

ITEM#: GMF1

20(OZ) / 600(ML)
IMPRINT AREA: 4"H X1.25"W

ITEM NO.	75	150	500	SET-UP	REPEAT SET-UP
GMF1	19.18	18.12	17.05	65.00	50.00
2ND COLOUR: 1.65(C)					5C

PRICE INCLUDES:

- 1 BOTTLE
- 1 COLOUR IMPRINT
- 1 GIFT BOX



WHITE RED GREY GREEN BLUE PACKAGING

NEW!



NU-WAVE WATER BOTTLE

CATCH THE NU-WAVE!

Now you have the most popular shape in water bottles today. Made of virtually indestructible TRITAN material, this water bottle is practical for many different activities such as gym, beach and a variety of indoor and outdoor activities including travel, work or school.

FEATURE

- 24 oz/ 720ml capacity
- Made of TRITAN and stainless steel
- Virtually indestructible
- Available in 4 bright colour options
- Stylish design
- 100% BPA free



NU-WAVE



COLOUR OPTIONS: ● ○ ● ●

ITEM#: TWB8

24OZ/ 720ML
IMPRINT AREA: 3"H X3"W
WRAPAROUND: 8"

ITEM NO.	72	144	504	SET-UP	REPEAT SET-UP
TWB8	8.99	7.99	6.49	65.00	50.00
2ND COLOUR: 1.65(C)				5C	

PRICE INCLUDES: - 1 BOTTLE
- 1 COLOUR IMPRINT AND GIFT BOX



BLACK CLEAR BLUE RED

NEW!



LA TOUR WATER BOTTLE

TAKE THE TOUR, ENJOY THE RIDE TO THE TOP!

Now you have the most popular shape in water bottles today. Made of virtually indestructible TRITAN material, this water bottle is practical for many different activities such as gym, beach and a variety of indoor and outdoor activities including travel, work or school.

FEATURE

- 24 oz/ 720ml capacity
- Made of TRITAN and stainless steel
- Virtually indestructible
- Available in 4 bright colour options
- Stylish design
- 100% BPA free



COLOUR OPTIONS: ● ● ● ●

ITEM#: TWB7

24OZ/ 720ML
IMPRINT AREA: 3"H X3"W
WRAPAROUND: 8"

ITEM NO.	75	150	500	SET-UP	REPEAT SET-UP
TWB7	8.99	7.99	6.49	65.00	50.00
2ND COLOUR: 1.65(C)				5C	

PRICE INCLUDES: - 1 BOTTLE
- 1 COLOUR IMPRINT AND GIFT BOX



SMOKE RED CLEAR BLUE



the
PINNACLE
SPORTS BOTTLE

The Tritan™ Advantage
WITHSTANDS SUBFREEZING TO BOILING TEMPERATURES!
THIS NEW REVOLUTIONARY HIGH TECH MATERIAL IS EXTREMELY IMPACT RESISTANT AND 100% BPA FREE!

COLOUR OPTIONS: ○ ● ● ● ● ● ●

REACH FOR THE SUMMIT!

The Pinnacle Sports Bottle is the ultimate sports bottle for hiking, camping, biking and all other outdoor activities. Made of virtually indestructible light weight Tritan and 100% BPA free it surpasses all other sports bottles. The easy access, wide mouth opening is ideal for adding ice cubes. Add a tight fitting spill proof lid with built in carry strap and you have the ultimate sports bottle. The Pinnacle Sports Bottle will certainly help you reach your goal!

Choose from an array of dazzling colours, this sturdy eco friendly water bottle will last you for years!

ITEM#: TWB10

24(OZ) / 720(ML)
IMPRINT AREA: 3"H X3"W

ITEM NO.	75	150	500	SET-UP	REPEAT SET-UP
TWB10	10.65	10.13	9.58	65.00	50.00
2ND COLOUR:	1.65(C)			5C	

PRICE INCLUDES:

- 1 BOTTLE
- 1 COLOUR IMPRINT



CLEAR RED ORANGE GREEN BLUE BLACK



The Tritan™ Advantage
WITHSTANDS SUBFREEZING TO BOILING TEMPERATURES!
THIS NEW REVOLUTIONARY HIGH TECH MATERIAL IS EXTREMELY IMPACT RESISTANT AND 100% BPA FREE!

the
TRIUMPH
SPORT HYDRATION BOTTLE

COLOUR OPTIONS: ○ ● ● ● ● ● ●

A PROVEN WINNER FOR ALL ATHLETES.

This sport inspired bottle is a must for all sport enthusiasts and athletes alike! Its ergonomic design makes it easy to grip; the innovative Free Flow spout creates quick drinking access, necessary for swift hydration. Made from lightweight yet sturdy Tritan this innovative hydration bottle endures total vigorous usage.

100 % BPA free, lightweight and virtually indestructible the Triumph Sports Hydration Bottle is the #1 choice of athletes.

Available in a wide variety of colors to compliment any winning team

ITEM#: TWB9

20(OZ) / 600(ML)
IMPRINT AREA: 2.5"H X2.5"W

ITEM NO.	75	150	500	SET-UP	REPEAT SET-UP
TWB9	10.65	10.13	9.58	65.00	50.00
2ND COLOUR:	1.65(C)			5C	

PRICE INCLUDES:

- 1 BOTTLE
- 1 COLOUR IMPRINT



CLEAR RED ORANGE GREEN BLUE SMOKE

PATENTED



the "In Style"
PILL ORGANIZER
 BOTTLE

SIMPLY YOUR LIFE

Introducing the new, sleek "In Style" pill organizer and water bottle combined... the practical, modern way to keep your pills and water handy. **Ideal to suit your lifestyle!**

This smart water bottle is equipped with a built-in 7-compartment pill organizer, so you'll never be without water to wash down your daily supplements or medications — even when you're on the go.

Time to take medication!

Avoid the unpleasant taste of swallowing pills without water. The "In Style" pill organizer bottle gives you easy access to your water and medication.

Each day is noted in English, French and Braille



Removable pill compartment for easy access and cleaning.



COLOUR OPTIONS: ● ● ● ● ● ● ●

ITEM#: PB55

20(OZ)/600(ML)
 IMPRINT AREA: 3"H X 2.5"W

ITEM NO.	75	150	500	SET-UP	REPEAT SET-UP
PB55	11.74	11.18	10.62	65.00	50.00
2ND COLOUR:	1.65(C)			5C	

PRICE INCLUDES:

- 1 BOTTLE
- 1 PORTABLE CUP
- 1 PILL ORGANIZER COMPARTMENT
- 1 COLOUR IMPRINT
- 1 GIFT BOX



RED PINK YELLOW BLACK BLUE GIFT BOX



SAMBA SHAKER



The handle has a hidden compartment for your powder mix.

COLOUR OPTIONS: ●●●●●

FEATURES

- Eco friendly
- Made of high clarity food safe plastic
- Space efficiency
- Fashionable
- Strong and leak proof

IDEAL FOR

- laptop cases
- briefcases
- purses



COLOUR OPTIONS: ●●●○

E FLASK

STAND IT UP OR LAY IT FLAT

In today's busy world, space and time is extremely important. The e flask bottle is a perfect fit in your carry on bag and office bag with your laptop, tablet, and cell phone

Eflask fits in your bag alongside your laptop and books. Together we can reduce the consumption of single-use bottles.

ITEM#: PB10

16(OZ)/475(ML)
IMPRINT AREA: 5.5"H X 3.5"W

ITEM NO.	75	150	500	SET-UP	REPEAT SET-UP
PB10	11.18	10.62	10.06	65.00	50.00

2ND COLOUR: 0.89(C)
5C

PRICE INCLUDES:
- 1 BOTTLE
- 1 COLOUR IMPRINT
- GIFT BOX



BLUE SMOKE RED CLEAR GIFT BOX

THE NEW, QUICK, EASY AND FUN WAY TO MIX YOUR DRINK!

The samba shaker is a practical and fun way to keep your drink mixed while on the go. Ideal to bring to the gym, work or school.

IDEAL FOR MIXING

- Sport hydration powders
- Protein energy mixtures
- Smoothies
- Nutrition
- Weight loss blends
- Weight gain blends

ITEM#: RS14

20(OZ)/600(ML)
IMPRINT AREA: 1.5"H X 3"W
WRAPAROUND: 8"W

ITEM NO.	75	150	500	SET-UP	REPEAT SET-UP
RS14	12.50	9.99	8.99	65.00	50.00

2ND COLOUR: 1.65(C)
5C

PRICE INCLUDES:
- 1 BOTTLE
- 2 MIXING BALLS
- 1 COLOUR IMPRINT
- 1 GIFT BOX



RED/YELLOW BLUE/YELLOW WHITE/PURPLE YELLOW/BLUE BLACK/RED GIFT BOX



Comes with corkscrew included in the cup!

A truly versatile on-the-go wine cup

COLOUR OPTIONS: ● ● ● ● ●

VINO OPENER TUMBLER



Stays cool for hours
Triple wall chilling system
Add ice cold water to chill your wine!

CHILL VINO 2 GO

COLOUR OPTIONS: ● ● ● ● ●

PORTABLE WINE CUP WITH CORKSCREW

- High quality plastic cup
- Double wall insulation
- Slide tab opening in lid
- Removable corkscrew inside cup base
- Spill-proof
- Unbreakable

100% BPA free
Hand wash only

Perfect cup for outdoor events, keeps wine cold and comes with handy corkscrew opener

ITEM#: VOC1

12(OZ)/350(ML)
IMPRINT AREA: 2.5"H X 2.5"W
WRAPAROUND: 8"W

ITEM NO.	72	144	504	SET-UP	REPEAT SET-UP
VOC1	9.99	8.99	7.99	65.00	50.00
2ND COLOUR:	0.89(C)			5C	

PRICE INCLUDES: - 1 WINE TUMBLER
- 1 COLOUR IMPRINT AND 1 GIFT BOX



THE NEXT GENERATION OF VINO 2 GO

- High quality plastic cup
- Triple wall insulation prevents condensation on exterior wall
- Slide tab opening in lid
- Easy fill water chilling system inside cup base
- Spill-proof
- Unbreakable

100% BPA free
Hand wash only
Do not freeze

Cold water inside inner chamber keeps your wine cup chilled
Great casual outdoor entertaining

ITEM#: IV3G

10(OZ)/480(ML)
IMPRINT AREA: 3"H X 3"W
WRAPAROUND: 8"

ITEM NO.	72	144	504	SET-UP	REPEAT SET-UP
IV3G	13.42	12.3	11.18	65.00	50.00
2ND COLOUR:	0.89(C)			5C	

PRICE INCLUDES: - 1 WINE TUMBLER
- 1 COLOUR IMPRINT AND 1 GIFT BOX





VINO 2 GO

double wall insulated wine tumbler

OUR ORIGINAL WINE TUMBLER

High quality plastic tumbler
 Double wall insulation
 Slide tab opening in lid
 Spill-proof
 Unbreakable

100% BPA free
 Hand wash only

A practical tumbler so you can enjoy wine on the go or outdoors, while keeping it cool

ITEM#: V2G

10 OZ / 295 ML
 IMPRINT AREA: 3"H X3"W
 WRAPAROUND: 3"W

ITEM NO.	72	144	504	SET-UP	REPEAT SET-UP
V2G	8.94	8.38	7.82	65.00	50.00
2ND COLOUR:	1.65(C)			5C	

PRICE INCLUDES: - 1 WINE TUMBLER
 - 1 COLOUR IMPRINT AND 1 GIFT BOX



COLOUR OPTIONS:



SET OF 2
JUST STACK AND GO!
 practical carry strap



STACKABLE VINO

Portable and stackable
 Unbreakable
 Practical for outdoor use
 Ideal for pool side, bbqs...
 Space saving
 Dishwasher proof
 100% bpa free

COLOUR OPTIONS:

ITEM #: VT 13

10(OZ)/295(ML)
 IMPRINT AREA: 1.25"H X 2"W
 WRAPAROUND: 7"

ITEM NO.	72	144	504	SET-UP	REPEAT SET-UP
VT13	10.06	9.5	8.94	65.00	50.00
2ND COLOUR:	1.65(C)			5C	

PRICE INCLUDES: - 1 SET OF 2 VINO CUPS AND CARRY STRAP
 - 1 COLOUR IMPRINT AND GIFT BOX





VINO TINI

2 IN 1 glass

A GLASS OF WINE OR MARTINI!

Serve what you want when you want!
Ideal entertaining glass for a party!
Rated # 1 most elegant and practical design party glass

Dishwasher proof
100% BPA free

ITEM#: VT1

MARTINI: 8OZ/250ML WINE: 15OZ/450ML
IMPRINT AREA: 1.75"H X 2"W
WRAPAROUND: 11"W

ITEM NO.	72	144	504	SET-UP	REPEAT SET-UP
VT1	13.42	12.3	11.18	65.00	50.00
2ND COLOUR:	1.65(C)			5C	

PRICE INCLUDES: - 1 VINO TINI
- 1 COLOUR IMPRINT
- GIFT BOX



GIFT BOX

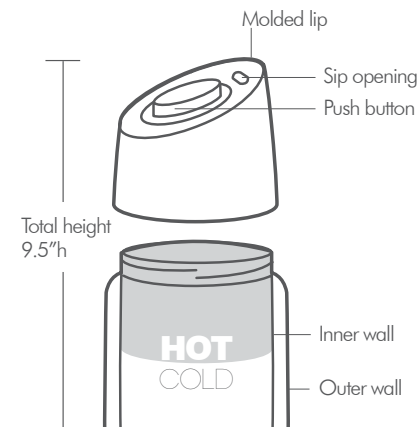

SIMPLY CLEAR

the bottle

GET ON THE LATEST TREND IN GLASS TRAVEL MUGS

Double wall heat resistant
Dishwasher safe
No after taste
Stays cold or hot for hours
Easy access, push button, instant flow
Press to drink
Leak proof



COLOUR OPTIONS: ● ● ●

ITEM#: DWG77

14(OZ)/400(ML)
IMPRINT AREA: 4"H X 2.5"W
WRAPAROUND: 8"W

ITEM NO.	72	144	504	SET-UP	REPEAT SET-UP
DWG77	20.14	19.58	19.02	65.00	50.00
2ND COLOUR:	1.65(C)			5C	

PRICE INCLUDES:

- 1 GLASS BOTTLE
- 1 COLOUR IMPRINT
- GIFT BOX



RED TEAL SMOKE GIFT BOX 79

PREMIER
PACKAGING
UNDECORATED
ADD 4.78(C)

Lids can be removed from either end of bottle.



ICE "T" 2 GO

The Ice Infuser Bottle to go

THE ICE TEA INFUSER TO GO

Remove bottom lid and insert tea into fine mesh infuser, then close
Half fill the bottle with hot water and steep as long as you wish
Insert ice cubes through the top opening and enjoy!

Heat resistant glass bottle
Silicone sleeve
Fine mesh infuser

100% BPA free
Dishwasher safe

Iced Coffee



COLOUR OPTIONS: ● ● ● ● ●

ITEM#: IT2GO

14(OZ)/400(ML)
IMPRINT AREA: 2.5"H X 2.5"W
WRAPAROUND: 7"W

ITEM NO.	75	150	500	SET-UP	REPEAT SET-UP
IT2GO	14.54	13.42	12.30	65.00	50.00
2ND COLOUR:	1.65(C)			5C	

PRICE INCLUDES:

- 1 GLASS BOTTLE WITH SILICONE SLEEVE
- TEA INFUSER
- 1 COLOUR IMPRINT
- GIFT BOX



Close opposite lid firmly before pouring in liquid



Lids can be removed from either end of bottle.



COLOUR OPTIONS:

TW2NS LIDS

Double wall glass tea bottle

Bora silicate heat resistant glass bottle
Double wall insulation
Fine mesh infuser

Add tea into the fine mesh infuser. Make sure opposite lid is well tightened. Pour in boiling water and close lid firmly. Let the tea infuse. Open opposite lid and enjoy a great cup of tea!

Double wall insulation keeps bottle cool to the touch

ITEM#: TWG1

14(OZ)/400(ML)
IMPRINT AREA: 4"H X 2.5"W
WRAPAROUND: 7"W

ITEM NO.	75	150	500	SET-UP	REPEAT SET-UP
TWG1	19.02	17.9	16.78	65.00	50.00
2ND COLOUR: 1.65(C)				5C	

PRICE INCLUDES:
- 1 TWIN LID BOTTLE
- TEA INFUSER
- 1 COLOUR IMPRINT
- GIFT BOX



ESCAPE BOTTLES

Double wall stainless steel
Acrylic outside shell
Screw top lid
Shock resistant
Easily detachable

100% BPA free
Dishwasher safe

Double wall insulation keeps beverages hot or cold



COLOUR OPTIONS:

ITEM#: SPO2

17(OZ)/500(ML)
IMPRINT AREA: 4"H X 2.5"W
WRAPAROUND: 8"W

ITEM NO.	75	150	500	SET-UP	REPEAT SET-UP
SPO2	14.54	13.42	12.3	65.00	50.00
2ND COLOUR: 1.65(C)				5C	

PRICE INCLUDES:

- 1 ESCAPE BOTTLE
- 1 COLOUR IMPRINT
- GIFT BOX



PREMIER PACKAGING UNDECORATED ADD 4.78(C)



Mini shock absorbers help protect the bottle!



Removable filter included
Laser engraving option
\$1.99(C)

Top view
See through glass lid



Tea infuser

SINGLE WALL GLASS WATER BOTTLE

ITEM#: SWG 20

20 OZ / 600 ML
IMPRINT AREA: 4"H X 2.25"W
WRAPAROUND: 7"

ITEM NO.	72	144	504	SET-UP	REPEAT SET-UP
SWG20	9.42	8.6	8.0	65.00	50.00
2ND COLOUR:	1.65(C)				5C

PRICE INCLUDES:
- 1 BOTTLE AND 1 COLOUR IMPRINT



BUMPER TEA BOTTLES

COLOUR OPTIONS: ●

Jazz up your bottles with our colorful array of silicone bumpers

DOUBLE WALL GLASS TEA INFUSER WITH SILICONE RING BANDS

- Dishwasher safe!
- BPA free!
- Eco Friendly
- No aftertaste
- Beverage stays cold or hot

ITEM#: DWG 12

14(OZ)/400(ML)
IMPRINT AREA: 2.75"H X 2.25"W
WRAPAROUND: 7"W

ITEM NO.	75	150	500	SET-UP	REPEAT SET-UP
DWG12	18.46	16.78	15.66	65.00	50.00
2ND COLOUR:	1.65(C)				5C

PRICE INCLUDES:
- 1 BUMPER BOTTLE
- 1 COLOUR IMPRINT AND 1 GIFT BOX
- 3 SILICON RING BANDS
- 1 TEA INFUSER



GIFT BOX



The original GLASS TEA AND WATER BOTTLE

DOUBLE WALL INSULATION

- For Hot & Cold
- Dishwasher safe!
- BPA free!
- Eco Friendly
- No aftertaste
- Bottle exterior stays cool

ITEM#: DWG 10

14 OZ / 400 ML
IMPRINT AREA: 4"H X 2.5"W
WRAPAROUND: 7"W

ITEM NO.	75	150	500	SET-UP	REPEAT SET-UP
DWG10	11.18	10.62	10.06	65.00	50.00
2ND COLOUR:	1.65(C)				5C
UPGRADE TO DEEP ETCH:	4.50(C)				
ENGRAVING ON LID:	1.99(C)				

PRICE INCLUDES:
- 1 BOTTLE AND 1 COLOUR IMPRINT

GLASS WATER BOTTLE With sport lid

ITEM#: GBD 400

(13OZ / 400ML)
IMPRINT AREA: 4"H X 2.5"W
WRAPAROUND: 7"

ITEM NO.	75	150	500	SET-UP	REPEAT SET-UP
GBD400	13.42	12.86	12.3	65.00	50.00
2ND COLOUR:	1.65(C)				5C
UPGRADE TO DEEP ETCH:	4.50(C)				
ENGRAVING ON LID:	1.99(C)				

PRICE INCLUDES:
- 1 BOTTLE
- 1 COLOUR IMPRINT



Filter

sport lid



PATENTED



Free recipe booklet included while quantities last



New & Improved With enlarged spout



FLAVOUR IT

GLASS WATER BOTTLE WITH FRUIT INFUSER

Single wall glass bottle
Integrated fruit infuser

100% BPA free
Dishwasher safe

Give your day a healthy spin, infuse your water with fresh fruit



FLAVOUR IT

ITEM#: SWG11

20 OZ / 600 ML
IMPRINT AREA: 4"H X 2.25"W
WARPAROUND: 7"

ITEM NO.	75	150	500	SET-UP	REPEAT SET-UP
SWG11	17.9	15.66	12.3	65.00	50.00

2ND COLOUR: 1.65(C)

PRICE INCLUDES:

- 1 BOTTLE, 1 COLOUR IMPRINT
- 1 GIFT BOX, 1 RECIPE BOOK

PREMIER
PACKAGING
UNDECORATED
ADD 4.78(C)



The Tritan™ Advantage

WITHSTANDS SUBFREEZING TO BOILING TEMPERATURES!
 THIS NEW REVOLUTIONARY HIGH TECH MATERIAL IS EXTREMELY IMPACT RESISTANT AND 100% BPA FREE!



COLOUR OPTIONS: ● ● ● ● ●

TRITAN™ WATER BOTTLE AND FRUIT INFUSER

Pure and healthy hydration especially for people on the go
 Ecological and inexpensive way to enjoy fruit infused water every day

100% BPA free
 Dishwasher safe

Ideal for:
 -School
 -Office
 -Travel
 -Gym

ITEM#: BTA 712

20 OZ / 600 ML
 IMPRINT AREA: 4" H X 2.25" W
 WRAPAROUND: 7"

ITEM NO.	75	150	500	SET-UP	REPEAT SET-UP
BTA712	14.54	13.42	12.3	65.00	50.00
2ND COLOUR: 1.65(C)				5C	

PRICE INCLUDES:
 - 1 BOTTLE
 - 1 COLOUR IMPRINT
 - 1 GIFT BOX



SMOKE RED ORANGE GREEN SKY BLUE GIFT BOX



FLAVOUR 2 GO

ITEM#: BTA 711S

20 OZ / 600 ML
 IMPRINT AREA: 4" H X 2.25" W
 WRAPAROUND: 7"

ITEM NO.	75	150	500	SET-UP	REPEAT SET-UP
BTA711	14.54	13.42	12.3	65.00	50.00
2ND COLOUR: 1.65(C)				5C	

PRICE INCLUDES:
 - 1 BOTTLE
 - 1 COLOUR IMPRINT AND 1 GIFT BOX



COLOUR OPTIONS: ○ ● ● ● ● ● ● ● ●



WHITE PURPLE TEAL BLACK GREEN BLUE RED YELLOW PINK GIFT BOX



Make your favourite flavour drink



MASON JAR

Single wall acrylic with straw

COLOUR OPTIONS: ● ● ● ● ●

ITEM#: MJ01

25(OZ)/750(ML)
 IMPRINT AREA: 2.75"H X 3"W (1 SIDE ONLY)
 WRAPAROUND: 7"

ITEM NO.	72	144	288	SET-UP	REPEAT SET-UP
MJ05	6.50	5.99	5.24	65.00	50.00
2ND COLOUR:	1.65(C)			5C	

PRICE INCLUDES:
 - 1 MASON JAR WITH STRAW
 - 1 COLOUR IMPRINT AND 1 GIFT BOX



SMOKE RED BLUE GREEN GIFT BOX

SHINDIG MOONSHINE

Lids available in black, gold
 straws available in red, yellow, black, green, orange and purple.



ITEM#: DM202-1

16(OZ)/480(ML)
 IMPRINT AREA: 1.5"H X 1.25"W

ITEM NO.	72	144	288	SET-UP	REPEAT SET-UP
DM202-1	8.99	7.99	7.50	65.00	50.00
2ND COLOUR:	1.65(C)			5C	

PRICE INCLUDES:
 - 1 JAR, LID AND STRAW
 - 1 COLOUR IMPRINT



COLOUR OF STRAW GOLD BLACK

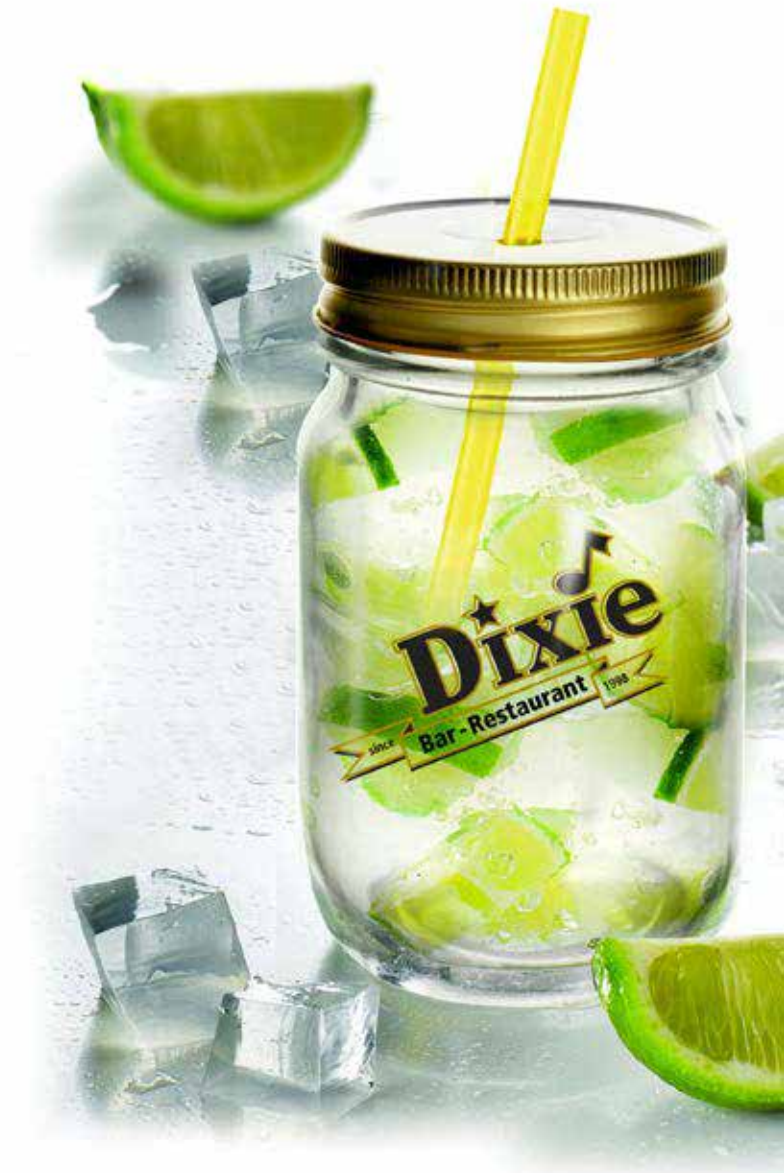

MUG OR GLASS JAR

With stainless steel lids and reusable straw

ITEM#: JU2

16(OZ)/480(ML)
 IMPRINT AREA: 3"H X 2.5"W
 WRAPAROUND: 3"H X 7"W

ITEM NO.	144	SET-UP	REPEAT SET-UP
JU2	6.16	65.00	50.00
2ND COLOUR:	1.65(C)		3C

PRICE INCLUDES:
 - 1 JAR, LID AND STRAW
 - 1 COLOUR IMPRINT



COLOUR OF STRAW GOLD BLACK



New & Improved!
YO 2 GO

- Clear acrylic body
- Double wall insulation
- Spoon is food safe ABS plastic
- Anti-slip silicone band
- Spill-proof
- Reusable

Perfect for filling with yogurt, lid holds add-ons such as cereal, fruit or nuts
 Eco-friendly and fits neatly into lunch or office bag

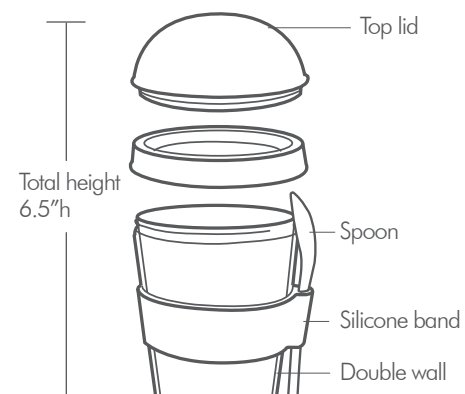

ITEM#: YO2GOS

12(OZ)/360(ML)
 IMPRINT AREA: 1.5"H X 2.25"W
 WRAPAROUND: 7"

ITEM NO.	72	144	504	SET-UP	REPEAT SET-UP
YO2GOS	11.8	10.06	8.94	65.00	50.00
2ND COLOUR:	1.65(C)				5C

PRICE INCLUDES:
 - 1 YO2GO WITH SPOON AND SILICON BAND
 - 1 COLOUR IMPRINT AND GIFT BOX

COLOUR OPTIONS: ●●●●●●



FOLDABLE WATER BOTTLE

METALLIC BOTTLES KEEP YOUR WATER COLDER UP TO 4 TIMES LONGER!

Rated #1 quality foldable bottle
 Rated #1 quality metallic mylar materia
 Bpa free
 Dishwasher safe



FB02 PINK

FB01 LIME



SECTOR
NO LIMITS

Keith's
Coffee

SNB01

SNB02

SILI-SQUEEZE

Revolutionary new hydra bottle

COLOUR OPTIONS: ● ● ● ● ● ○

THE ULTIMATE SQUEEZE BOTTLE

100% bpa free!
 100% phthalates free
 Dishwasher safe!
 Eco friendly
 No after taste
 Odourless
 Food grade approved
 FDA approved
 Reusable and 100% recyclable
 Virtually unbreakable
 Light weight
 Heat resistant up to 300 F° freezable up to -40 F°

ITEM#: SNB 01

20OZ / 600 ML
 IMPRINT AREA: 1.25"H X 1.5"W

ITEM NO.	75	150	500	SET-UP	REPEAT SET-UP	PRICE INCLUDES:
SNB01	13.39	12.64	11.92	65.00	50.00	- 1 BOTTLE - 1 CARABINEER - 1 COLOUR IMPRINT - 1 HANG TAG
2ND COLOUR:	1.65(C)			5C		

ITEM#: SNB 02

22OZ / 650 ML
 IMPRINT AREA: 3"H X 2"W

ITEM NO.	75	150	500	SET-UP	REPEAT SET-UP	PRICE INCLUDES:
SNB02	12.77	12.48	12.07	65.00	50.00	- 1 BOTTLE - 1 CARABINEER - 1 COLOUR IMPRINT - 1 HANG TAG
2ND COLOUR:	1.65(C)			5C		



ITEM#: FB01

16OZ / 500 ML
 SIZE: 10.75"H
 IMPRINT AREA: 3.5"H X 3"W

ITEM NO.	100	500	1000	SET-UP	REPEAT SET-UP	PRICE INCLUDES:
SNB01	3.34	3.12	2.78	65.00	50.00	- 1 BOTTLE AND 1 COLOUR IMPRINT
2ND COLOUR:	0.89(C)			5C		

PRICE INCLUDES:
 - 1 BOTTLE AND 1 COLOUR IMPRINT

ITEM#: FB02

16OZ / 500 ML
 SIZE: 10.75"H
 IMPRINT AREA: 3"H X 3"W

ITEM NO.	100	500	1000	SET-UP	REPEAT SET-UP	PRICE INCLUDES:
SNB02	3.34	3.12	2.78	65.00	50.00	- 1 BOTTLE AND 1 COLOUR IMPRINT
2ND COLOUR:	0.89(C)			5C		

PRICE INCLUDES:
 - 1 BOTTLE AND 1 COLOUR IMPRINT



THE DEEP FREEZE HYDRATION BOTTLE

COLOUR OPTIONS: ● ● ●

THE ULTIMATE COOLNESS IN HYDRATION BOTTLES

This re-freezable bottle will keep your favourite beverage chilled for hours, even on a hot summer day! The Deep Freeze Hydration technology eliminates the need for ice! The innovative honeycomb food safe, freezing gel keeps your drink cold for up to 12 hours. NO more watered down drinks! Place this innovative bottle in the freezer for one hour or more before using. Your drink will remain cold for hours! Place it in your cooler once frozen and it will even chill the cooler! Double walled Tritan combined with honeycomb gel technology makes the Deep Freeze hydration bottle one of the most innovative hydration bottles on the market today!

Available in 3 vibrant colours with easy grip strap, grab yours today!

ITEM#: PF02

20(OZ) / 600(ML)
IMPRINT AREA: 4"H X 3"W
WRAPAROUND: 8"W

ITEM NO.	48	144	504	SET-UP	REPEAT SET-UP
PF02	14.92	14.38	13.85	65.00	50.00
2ND COLOUR:	1.65(C)				5C

PRICE INCLUDES:
- 1 BOTTLE WITH 1 COLOUR IMPRINT
- 1 GIFT BOX



BLUE BLACK RED PACKAGING

The Tritan™ Advantage

WITHSTANDS SUBFREEZING TO BOILING TEMPERATURES!
THIS NEW REVOLUTIONARY HIGH TECH MATERIAL IS EXTREMELY IMPACT RESISTANT AND 100% BPA FREE!



COLOUR OPTIONS: ● ● ●

PERMA FROST *Hydra bottle*

KEEPS YOUR FAVOURITE BEVERAGE "FROSTY" FOR HOURS!

Eliminates the need for ice as the technology keeps drinks "crushed ice" cold for hours without the watered down effect of ice!

Just place it in freezer for one hour or more prior to use and enjoy !

- re-freezable built in gel pack
- double wall tritan
- flip top easy to clean spout
- bpa free
- stays cold for hours
- carry on handle
- "bite it" silicone sport lid with straw

ITEM#: PF 01

20(OZ)/600(ML)
IMPRINT AREA: 4"H X 2.5"W
WRAPAROUND: 8"

ITEM NO.	48	144	504	SET-UP	REPEAT SET-UP
PF01	13.42	12.86	12.3	65.00	50.00
2ND COLOUR:	1.65(C)				5C

PRICE INCLUDES:
- 1 BOTTLE WITH 1 COLOUR IMPRINT
- 1 GIFT BOX





Wide mouth feature
for ice cubes

The Kids

STAINLESS STEEL WATER BOTTLE

COLOUR OPTIONS: ● ● ● ●

ITEM#: SSB 2

18OZ / 500 ML
SIZE: 9"H X 2.75" DIAM
IMPRINT AREA: 4"H X 2.75"W
WRAPAROUND: 8"W

ITEM NO.	48	144	504	SET-UP	REPEAT SET-UP
SSB2	6.70	6.14	5.58	65.00	50.00
2ND COLOUR: 1.65(C)				5C	

PRICE INCLUDES:
- 1 BOTTLE WITH CARABINNE
- 1 COLOUR IMPRINT



BLUE RED LIME SILVER



REVOLUTIONARY
FREE-FLOW TOP

IDEAL FOR SPORTS!

The Athletes

STAINLESS STEEL WATER BOTTLE

COLOUR OPTIONS: ● ● ● ●

ITEM#: SSB9

24 OZ / 720 ML
IMPRINT AREA: 2.75"W X 3"H
WRAPAROUND: 8"W

ITEM NO.	50	500	1000	SET-UP	REPEAT SET-UP
SSB9	7.82	7.6	7.26	65.00	50.00
2ND COLOUR: 1.65(C)				5C	

PRICE INCLUDES:
- 1 SSB9 BOTTLE
- 1 COLOUR IMPRINT



LIME BLUE SILVER RED



With handle built into the lid

SPORTS WATER BOTTLE

ITEM#: BTA700

24OZ / 720ML
HEIGHT: 8.85"H
IMPRINT AREA: 4"H X 2 1/4"W
WRAPAROUND: 7"

ITEM NO.	75	150	500	1000	SET-UP	REPEAT SET-UP
BTA700	9.65	9.21	8.56	8.23	65.00	50.00
2ND COLOUR:	1.65(C)					6C

PRICE INCLUDES:
- 1 BOTTLE WITH
- 1 COLOUR IMPRINT



GRAPHITE WHITE RED GREEN BLUE



TURBO SHAKER BOTTLE

Ideal for mixing sport hydration powder or protein sport mixes.
Comes with stainless steel blending ball and 24OZ tritan bottle with flip top lid and carry handle.
Ideal for your next work out!

ITEM#: TSB7

24OZ / 720ML
HEIGHT: 8.85"H
IMPRINT AREA: 4"H X 2 1/4"W
WRAPAROUND: 7"

ITEM NO.	75	250	500	1000	SET-UP	REPEAT SET-UP
TSB7	10.82	10.45	10.03	9.83	65.00	50.00
2ND COLOUR:	1.65(C)					6C

PRICE INCLUDES:
- 1 BOTTLE WITH 1 SHAKER BALL
- 1 COLOUR IMPRINT



GRAPHITE GREEN RED WHITE BLUE



TEA BALL

Glass mug with silicone tea ball infuser

Unique and modern mug with low slung handle

COLOUR OPTIONS: ● ● ● ● ● ○

ITEM#: TD 2

16.75OZ / 495ML
 IMPRINT AREA: 1.25"H X 2"W
 WRAPAROUND: 8"W



ITEM NO.	72	144	504	SET-UP	REPEAT SET-UP
TD2	14.54	13.42	11.18	65.00	50.00
2ND COLOUR:	0.89(C)			5C	

PRICE INCLUDES:
 - 1 GLASS MUG WITH SILICONE TEAB ALL INFUSER
 - 1 COLOUR IMPRINT
 - 1 GIFT BOX



The PRESS CAFE

SUPER THERMO!

Press to drink and release to seal
 Keeps your coffee hot for 6~8 hours
 Spill and leak proof

COLOUR OPTIONS: ● ● ● ● ●

ITEM#: V599

14 OZ / 420 ML
 IMPRINT AREA: 2.5"W X 1.5"H
 WRAPAROUND: 8"W



ITEM NO.	50	100	200	400	SET-UP	REPEAT SET-UP
V599	17.36	16.78	16.24	15.66	65.00	50.00
2ND COLOUR:	1.65(C)			6C		

PRICE INCLUDES:
 - 1 TUMBLER WITH 1 COLOUR IMPRINT
 - 1 GIFT BOX

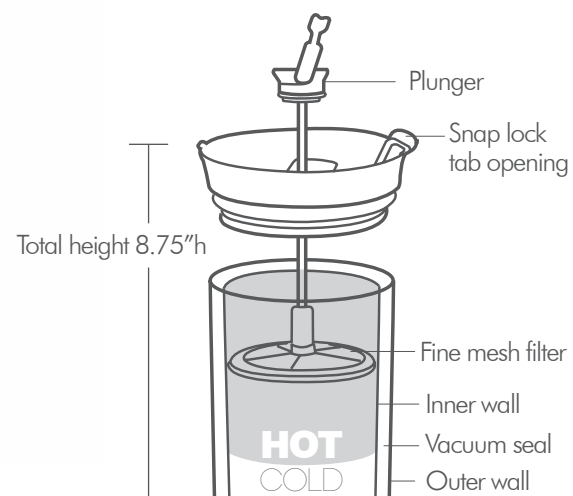

COLOUR OPTIONS: ● ● ● ● ●

The **HOT PRESS**
Tea & coffee maker

STAINLESS STEEL VACUUM INSULATED TUMBLER

1. Place tumbler on table securely.
2. After removing lid and plunger, add coarse ground coffee or loose tea to the inner cylinder.
3. Pour hot water into tumbler and allow 2~3 minutes to brew.
4. Gently press plunger until completely down.
5. Enjoy the deep infusion taste!

ITEM#: FP02

16OZ / 480 ML
IMPRINT AREA : 3.5"H X 2.5"W
WRAPAROUND : 7"W

ITEM NO.	50	150	500	SET-UP	REPEAT SET-UP
FP02	20.14	19.02	17.9	65.00	50.00
2ND COLOUR: 1.65(C)				5C	
PRICE INCLUDES:					
- 1 TUMBLER WITH 1 COLOUR IMPRINT					
- 1 GIFT BOX					



The **MODERN PRESS**
Tea & coffee maker

GLASS INTERIOR / TRANSPARENT ACRYLIC EXTERIOR

1. place tumbler on table securely.
2. after removing lid and plunger, add coarse or medium grind coffee or loose tea to the inner cylinder.
3. pour hot water into tumbler and allow 2~3 minutes to brew.
4. gently press plunger until completely down.
5. enjoy the deep infusion taste!



COLOUR OPTIONS: ● ● ●

ITEM#: FP03

16OZ / 480 ML
IMPRINT AREA : 3.5"H X 2.5"W
WRAPAROUND : 7"W

ITEM NO.	72	144	504	SET-UP	REPEAT SET-UP
FP03	20.14	19.02	17.9	65.00	50.00
2ND COLOUR: 1.65(C)				5C	

PRICE INCLUDES:
- 1 MODERN PRESS
- 1 COLOUR IMPRINT
- 1 GIFT BOX



NEW



TEA TIME MUG SET

MAKE TIME FOR TEA WITH THE TEA TIME MUG SET!

This colourful porcelain Tea Time Mug Set is a breath of fresh air! Vibrant colors set the tone for the avid tea drinker.

This large capacity 15oz/580 ml mug comes complete with a micro mesh stainless steel strainer for loose tea and a lid that functions as a saucer when it's time to enjoy your tea.

Ideal for the novice tea drinker or connoisseur alike, The Tea Time Mug has everything that you need to relax and enjoy a wonderful cup of tea!

COLOUR OPTIONS: ● ○ ● ● ●

ITEM#: TD4

15(OZ) / 580(ML)
IMPRINT AREA: 3"H X 3"W
WRAPAROUND: 7.5"W

TD4	72	144	504	1440	SET-UP	REPEAT SET-UP
IMPRINT	18.96	17.84	16.72	15.6	65.00	50.00
DEEP ETCH	23.36	18.91	17.79	16.67	75.00	60.00

2ND COLOUR IMPRINT: 0.89(C) 6C
UPGRADE TO DEEP ETCH : 4.50(C) 2ND LOCATION, DEEP ETCH: 6.00(C)
PERSONALIZATION : 4.50(C)

PRICE INCLUDES:
- 1 MUG WITH 1 COLOUR IMPRINT
- 1 GIFT BOX



BLACK WHITE RED GREEN BLUE GIFT BOX

SUPER PACK PROTECTIVE PACKAGING ADD 6.20(G) PER CASE OF 36

NEW



Grate N TOP

TOPPING GRATER AND GLASS MUG SET

Make your own specialty coffee with help from our new topping grater. Whether you choose to decorate your coffee or sweeten it with nature's purest confections, our delightful offerings of dark chocolate rock or hard maple sugar snowflake will elevate your daily coffee to heavenly perfection.



DARK CHOCOLATE ROCK (CHOC)

MAPLE SUGAR SNOWFLAKE (MAP)

GRATE N TOP MUG SET INCLUDES:
 -GLASS MUG WITH ONE COLOR PRINT
 -STAINLESS STEEL GRATER
 -CHOICE OF TOPPING: DARK CHOCOLATE ROCK OR HARD MAPLE SUGAR SNOWFLAKE
 -GIFT BOX

ITEM#: GNT SET

CAPACITY: 13 1/2" OZ / 398 ML
 IMPRINT AREA: 2 1/2"W X 2 1/4"H
 DEEP ETCH AREA: 2 1/2"W X 2 1/4"H
 WRAPAROUND: 7 1/2"W X 2 1/4"H

ITEM NO.	48	144	288	SET-UP	REPEAT SET-UP
GNT SET	15.34	14.38	12.50	65.00	50.00
2ND COLOUR:	1.65(C)	UPGRADE TO DEEP ETCH : 4.50(C)		5C	
2ND LOCATION, DEEP ETCH:	6.00(C)				
PERSONALIZATION :	4.50(C)				

PRICE INCLUDES:
 - 1 GRATE N TOP SET
 - 1 COLOUR IMPRINT

SUPER PACK PROTECTIVE PACKAGING ADD 6.20(G) PER CASE OF 36



GIFT BOX

NEW

A prestige set that will get your client maximum exposure!



QUARTETTO

Espresso Gift Set

Enjoy the world's favorite coffee that comes in the smallest cup: Espresso! Coffee lovers are becoming more invested than ever before in this specialty brew: It's quality, it's status and of course, it's distinctive cup size.



ENJOY YOUR DAILY COFFEE SHOT IN THESE FOUR MINIATURE VERSIONS OF CLASSIC COFFEE MUG STYLES

COLOUR OPTIONS: ●

BLACK MATTE OUTSIDE / GLOSSY INSIDE

THESE BOXED ESPRESSO CUPS FEATURE MATTE BLACK FINISH, ETCHED LOGO ON EVERY CUP, AN ELEGANT HIGH END PRESENTATION BOX WITH MAGNETIC CLOSURE AND PRINTED LOGO

ITEM	CAPACITY	IMPRINT AREA	DEEP ETCH AREA
EPM1	3.3OZ/100ML	1.25"W X 1.25"H	1"W X 1"H
EPM2	3.3OZ/100ML	1.25"W X 1"H	1"W X 0.75"H
EPM3	4OZ / 112ML	1.25"W X 1.5"H	1"W X 1.5"H
EPM4	3.3OZ/100ML	1"W X 0.75"H	0.75"W X 0.5"H

ITEM#: EPM SET

ITEM NO.	48	144	288	SET-UP	REPEAT SET-UP
EPM SET	38.38	32.62	29.50	108	90
2ND COLOUR:	1.65(C)				5C
UPGRADE TO DEEP ETCH :	4.50(C)				
2ND LOCATION, DEEP ETCH:	6.00(C)				
PERSONALIZATION :	4.50(C)				

PRICE INCLUDES:

- 4 MINI-MUG STYLE ESPRESSO CUPS WITH ETCHED OR 1 COLOUR IMPRINT LOGO
- GIFT BOX WITH ONE COLOR PRINT



MADE OF
100%
FINE
BONE
CHINA

NATURE GARDEN'S

MUG

Made of 100% fine bone china!
Exquisite raised texture motifs
Lightweight yet extremely durable
Large capacity 18oz

ITEM#: MUG221-224

15(OZ)/450(ML)
IMPRINT AREA:
1"H X 0.25"W ON HANDLE ONLY

ITEM NO.	72	144	288	SET-UP	REPEAT SET-UP
MUG221					
MUG221	9.52	9.23	8.94	65	50
MUG221					
MUG221					

UPGRADE TO DEEP ETCH ON HANDLE ADD \$4.50(C) 5C
PRICE INCLUDES:
- 1 FRUIT MUG WITH 1 COLOUR IMPRINT ON HANDLE
- GIFT BOX
SUPER PACK PROTECTIVE PACKAGING ADD 6.20(G) PER CASE OF 36



CANTALOUPE MUG224 PINEAPPLE MUG222 CUCUMBER MUG221 LYCHEE MUG223 GIFT BOX

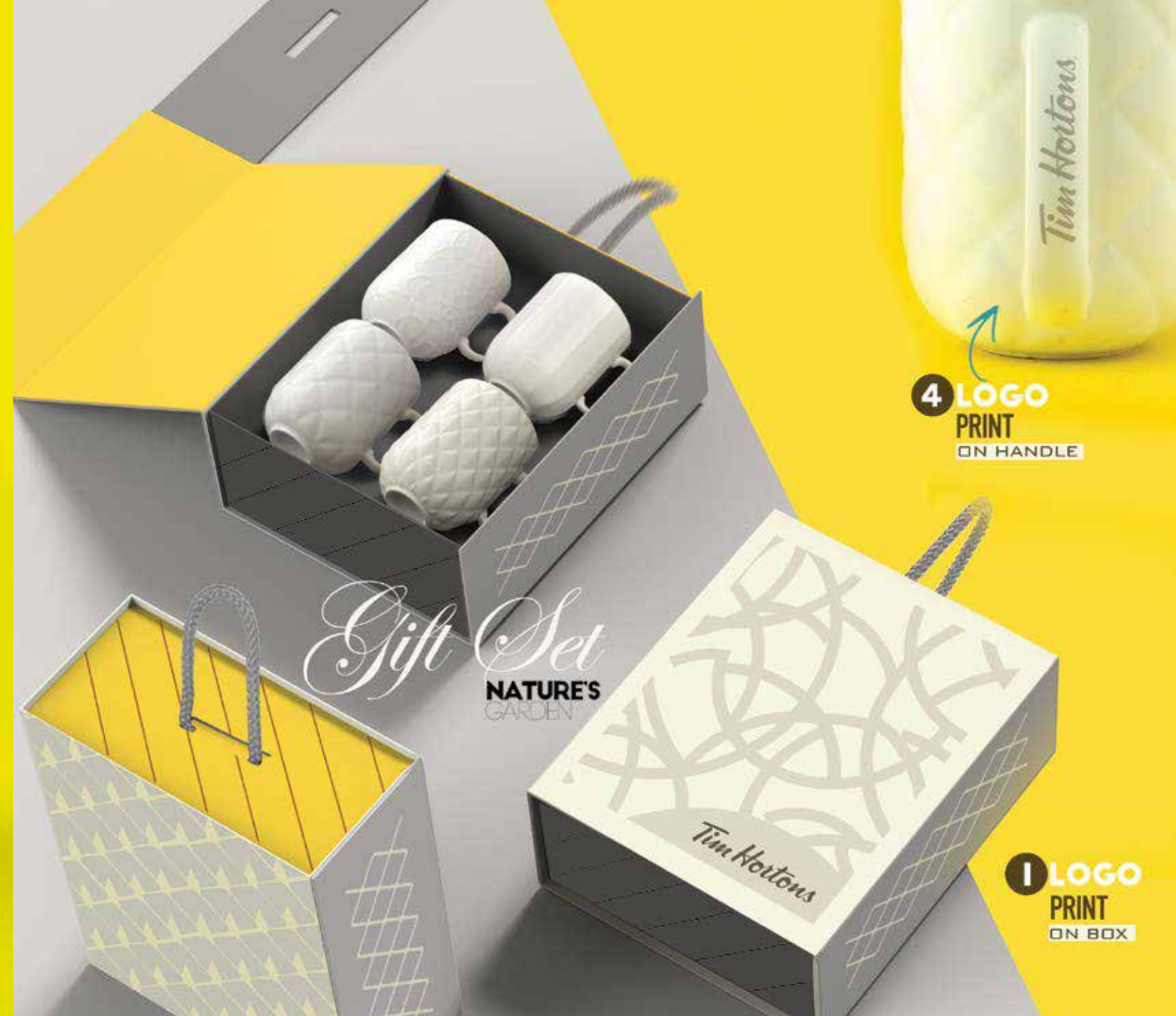

INSPIRED BY NATURE'S WONDERFUL DESIGNS!

All four mugs have unique nature-inspired and complementary motifs.

This beautiful set will have pride of place in any home, be it for special occasions or every day use.

From pleasantly textured motifs, modern all-white colour and fine bone china quality to the magnetic locking frame gift box, this retail-styled gift set has all the grace and charm for lasting appeal.

ITEM#: NG-SET

15(OZ)/450(ML)
IMPRINT AREA: 1.75"H X 3.75"W (GIFT BOX)
1"H X 0.25"W (MUG)

ITEM NO.	48	144	288	SET-UP	REPEAT SET-UP
NG SET	44.78	40.3	36.50	75	60
2ND COLOUR PRINTING NOT AVAILABLE					5C
UPGRADE TO DEEP ETCH : 18(C)					

PRICE INCLUDES:
- 1 MAGNETIC GIFT BOX PRINTED
- 4 FINE BONE CHINA MUGS PRINTED
- SAME LOGO ON ALL 5 ITEMS

the
HOLIDAY
tea
Gift Set



Open this luxurious jet black gift box, decorated with an artistic Japanese leaf pattern, and you'll be inspired. A beautiful sparkling mug set and accompanying gourmet tea case await you.

Holiday tea set includes imprints on magnetic locking frame gift box, gourmet tea case and both sparkling mugs.

THE PRESTIGIOUS WAY TO ENJOY YOUR PERFECT TEA

As the firelight reflects on these beautiful sparkling mugs, sip our gourmet full leaf tea and enjoy a moment of well-deserved achievement.

A GIFT OF DISCREET OPULENCE



COLOUR OPTIONS: ● ● ● ● ●

ITEM#: HTG1

14(OZ)/400(ML)
IMPRINT AREA: 1.75"H X 2.75"W (GIFT BOX)
1.25"H X 2"W (MUG 550)
3.75"H X 1.5"W (TEA TIN)

ITEM NO.	48	144	288	SET-UP	REPEAT SET-UP
HTG1	43.66	42.54	38.50	75	60
	2ND COLOUR: 1.65(C)				5C

PRICE INCLUDES:
1 MAGNETIC GIFT BOX PRINTED
2 CERAMIC MUGS PRINTED
1 TEA CASE PRINTED
SAME LOGO ON ALL 4 ITEMS

CHOOSE FROM 4 *Asobu* tea options



RED GOLD GREEN BLUE SILVER



Asobu Tea

Loose leaf green or black tea in tantalizing flavors
Plus an added sweet surprise of flavored rock sugar

ITEM#: ASOBU TEA

TEA WEIGHT: 1.4OZ/ 40G
ROCK SUGAR: 0.7OZ/ 20G
WHITE TEA TIN IMPRINT AREA: 1.5"W X 3.75"H
OTHER TEA TINS IMPRINT AREA: 2.25"D

ITEM NO.	25	50	144	SET-UP	REPEAT SET-UP
TT/1					
TA-100					
TC-100	11.18	10.63	10.06	65	50
TE-100					
TF-100					
2ND COLOUR:	1.65(C)				5C

PRICE INCLUDES:
- 1 COLOUR PRINT ON TEA TIN
- 1 GIFT BOX



GIFT BOX



ASOBU TEA Gift Set

A luxurious tea gift set
Loose leaf green or black tea
in tantalizing flavors
Plus an added sweet surprise of flavored rock sugar

ITEM#: LX2 TEA

15OZ/ 450 ML
IMPRINT AREA: 1.5"H X 2.5"W(GIFT BOX)
1.5"H X 2.25"W(TD1) 2.5"D(TEA TIN)

ITEM NO.	24	48	72	SET-UP	REPEAT SET-UP
LX2 TEA	33.58	32.46	31.34	75	60
2ND COLOUR:	1.65(C)				5C

PRICE INCLUDES:
- 2 TEA TINS AND GIFT BOX
- 1 COLOUR IMPRINT ON BOTH TEA TIN LIDS AND GIFT BOX
- SAME LOGO PRINT ON ALL 3 ITEMS

4 Asobu tea options
CHOOSE FROM
which include flavoured loose tea & rock sugar



NEW



MY "IT"
Gift Set

HAVE YOUR FAVOURITE ASOBU TEA ON THE GO

TEA PARTY
Gift Set

The prestigious way to enjoy your perfect mug of Asobu loose tea and rock sugar. This mug's deep infusion makes steeping your asobu Teas an unforgettable experience.

- packaged in a prestigious gift box with magnetic locking frame
- laser cut insert and carry on handle
- customized print on box included!

ITEM#: TD1 T-SET

15OZ/ 450 ML
IMPRINT AREA: 2"H X 3"W(GIFT BOX)
1.5"H X 2.25"W(TD1) 2.5"D(TEA TIN)

ITEM NO.	24	48	72	SET-UP	REPEAT SET-UP
TD1 T-SET	32.58	31.46	30.34	75	60
2ND COLOUR:	1.65(C)			5C	

PRICE INCLUDES:
- 1 TEA TINS, 1 TEA MUG, 1 GIFT BOX
- 1 COLOUR IMPRINT ON TEA TIN, TEA MUG AND GIFT BOX

4 Asobu tea options
CHOOSE FROM

which include flavoured loose tea & rock sugar



A wonderful gift set for all your tea needs. Have your favourite asobu teas on to go.

- Packed in a prestigious gift box with magnetic locking frame
- Laser cut insert and carry on handle
- Customized print on box included!

ITEM#: DWG12 T-SET

14OZ/ 400 ML
IMPRINT AREA: 2"H X 2.5"W(GIFT BOX)
2.25"H X 2.75"W(DWG12) 2.5"D(TEA TIN)

ITEM NO.	24	48	72	SET-UP	REPEAT SET-UP
DWG12 T-SET	32.58	31.46	30.34	75	60
2ND COLOUR:	1.65(C)			5C	

PRICE INCLUDES:
- 1 GIFT BOX, 1 BUMPER BOTTLE & 1 TEA TIN
- 1 COLOUR IMPRINT ON GIFT BOX, TEA TIN AND BOTTLE
- SAME LOGO ON ALL 3 ITEMS

4 Asobu tea options
CHOOSE FROM

which include flavoured loose tea & rock sugar



BOTTLE COLOUR OPTIONS



the **Tea time**
Gift Set

*Invest in a gift presentation that will be
Memorable for years to come!*

- This tea set includes:
- Ceramic tea mug with matching lid – 4 color options
 - Stainless steel tea infuser
 - Asobu loose leaf tea tin (50g) – 4 flavorful options
 - Gift box with magnetic closure
 - 3 logo imprints – bottle, tea tin lid and gift box



The original
TEA PARTY
MUG set

DEEP INFUSER MUG GREAT FOR GOURMET TEA
Heat resistant glass

ITEM#: TD1

15OZ/ 450 ML
IMPRINT AREA ON GLASS: 1.5" H X 2.25" W

ITEM NO.	72	144	504	1440	SET-UP	REPEAT SET-UP
TD1	17.9	16.78	15.66	14.54	75	60
2ND COLOUR: 0.89(C)		UPGRADE TO DEEP ETCH: 4.50(C)		5C		
2ND LOCATION, DEEP ETCH: 6.00(C)						
PERSONALIZATION: 4.50(C)						

- PRICE INCLUDES:
- 1 TD1 WITH 1 COLOUR IMPRINT
 - GIFT BOX



Laser engraving option: \$2.50(c)
Engraving area: 1.5" h x 1.5" w

GIFT BOX

Our best-selling tea infuser is now available in colorful and glossy finish ceramic options. A large ceramic tea mug with stainless steel infuser and matching ceramic lid to keep your tea hot.

Both items are nestled in an attractive contemporary design gift box with magnetic closure. This new gift set is being offered with 3 imprint locations – on the bottle, the tea tin lid and the front of the gift box.

A keepsake gift as this will keep your brand in view on a daily basis, fulfilling the objectives of pleasing customers while retaining their attention.

ITEM#: TD4 T-SET

IMPRINT AREA:
GIFT BOX: 4.5"W X 1.75" H / TD4 TEA MUG: 3"W X 3"H / TEA TIN: 2.5"D

ITEM NO.	48	96	144	SET-UP	REPEAT SET-UP
TD4 T-SET	35.25	33.54	31.58	67.5	54
2ND COLOUR: 1.65(C)		5C			

- PRICE INCLUDES:
- 1 CERAMIC MUG WITH LID AND TEA INFUSER
 - 1 ASOBU LOOSE LEAF TEA TIN (50G)
 - 1 GIFT BOX WITH MAGNETIC CLOSURE
 - SAME LOGO ON ALL 3 ITEMS

CHOOSE FROM
4 Asobu tea options

which include flavoured loose tea & rock sugar



WHITE BLACK BLUE RED GREEN TEA DIFFUSER

NEW



Café

POUR OVER MUG

THE ZEN COFFEE EXPERIENCE

Fine tune your coffee experience with the pour over mug. This minimalist approach to coffee unlocks the delicate aromas of your favorite coffee blend. Incorporate a meditative moment in your day while your coffee “blooms” before your eyes. Glossy finish on high quality ceramic coffee mug. Silicone coaster for dripper prevents spills. Durable ceramic dripper has glossy finish (available in white only)

COLOUR OPTIONS: ● ● ○

ITEM#: MUG 123

CAPACITY: 16OZ/ 450 ML
 IMPRINT AREA: 3 1/2"W X 1 1/2"H WRAPAROUND: 10"W X 1 1/2"H
 DEEP ETCH AREA: 3 1/2"W X 1 1/2"H

MUG123	72	144	288	SET-UP	REPEAT SET-UP
IMPRINT	14.38	13.04	13.42	65.00	50.00
DEEP ETCH	16.20	15.29	14.59	75.00	60.00
2ND COLOUR: 1.65(C)				2ND LOCATION, DEEP ETCH: 6.00(C)	5C
PERSONALIZATION :	4.50(C)				

PRICE INCLUDES:

- 1 MUG/DRIPPER/SILICONE COASTER
- 1 COLOUR IMPRINT/ DEEP ETCH LOGO
- 1 GIFT BOX

SUPER PACK PROTECTIVE PACKAGING ADD 6.20(G) PER CASE OF 24



RED

BROWN

WHITE

GIFT BOX



HAPPY TRAILS

COFFEE • TEA MUG

ALWAYS ON THE RIGHT PATH

This stunning porcelain mug will certainly make you smile when sipping your favourite beverage. This "camping" style mug comes in an array of four nature inspired colors, giving you that outdoor feeling without compromising quality. Relax, be happy and get back to nature with the Happy Trails mug. Work and school never felt so good!

COLOUR OPTIONS:

ITEM#: CFM16

14(OZ) / 420(ML)
 IMPRINT AREA: 1.75"H X 2.5"W

ITEM NO.	72	144	288	SET-UP	REPEAT SET-UP
CFM16	8.92	8.65	8.34	65	50
2ND COLOUR:	0.89(C)				5C
UPGRADE TO DEEP ETCH :	4.50(C)				
2ND LOCATION, DEEP ETCH :	6.00(C)				
PERSONALIZATION ADD :	4.50(C)				

PRICE INCLUDES:

- 1 MUG WITH COLOUR IMPRINT OR DEEP ETCH
- 1 GIFT BOX

SUPER PACK PROTECTIVE PACKAGING ADD 6.20(G) PER CASE OF 36



GREY

ORANGE

YELLOW

GREEN

GIFT BOX



Retro vibe CERAMIC CUP

Looking for that cool retro vibe? Take a look at our newest creation: NOT PAPER CUP! We've captured the essence of the iconic paper coffee cup and given it a redesign: Durable ceramic, eco-friendly and a fashion forward muted colour selection. Single wall construction. Glossy interior and matte exterior finish.

COLOUR OPTIONS: ● ● ● ● ●

ITEM#: CUP 101

CAPACITY: 11 OZ/ 325 ML
 IMPRINT AREA: 3"W X 2"H WRAPAROUND: 8"W X 2"H
 DEEP ETCH AREA: 2"W X 2"H

CUP101	72	144	288	SET-UP	REPEAT SET-UP
IMPRINT	6.70	6.22	5.74	65.00	50.00
DEEP ETCH	8.92	8.19	5.74	75.00	60.00

2ND COLOUR: 1.65(C) 5C
 2ND LOCATION, DEEP ETCH : 6.00(C)
 PERSONALIZATION ADD : 4.50(C)

PRICE INCLUDES:
 - 1 CUP WITH 1 COLOUR IMPRINT OR DEEP ETCH
 - 1 GIFT BOX

SUPER PACK PROTECTIVE PACKAGING ADD 6.20(G) PER CASE OF 36



BROWN SMOKE BLUE RED MOSS LIGHT GRAY GIFT BOX

NEW



Ruby MUG

SIP & SAVOUR CERAMIC MUG

Feel like a coffee taster every day! The fluted shape of this ceramic mug is designed to capture the coffee aromas for the nose and concentrate the flavors into every sip of coffee you take.

This quality ceramic mug comes in a selection of muted fashion colors. Glossy interior and matte exterior finish. Perfect for printing or etching.

COLOUR OPTIONS: ● ● ● ●

ITEM#: MUG 888

CAPACITY: 16OZ / 450 ML
 IMPRINT AREA: 2 1/2" W X 2"H WRAPAROUND: 7 1/2"W X 2"H
 DEEP ETCH AREA: 2 1/2"W X 2"H

MUG888	72	144	288	SET-UP	REPEAT SET-UP
IMPRINT	8.57	8.70	8.01	65.00	50.00
DEEP ETCH	10.67	10.14	9.51	75.00	60.00
2ND COLOUR: 0.89(C)					5C
2ND LOCATION, DEEP ETCH : 6.00(C)					
PERSONALIZATION ADD : 4.50(C)					

PRICE INCLUDES:

- 1 MUG
- 1 COLOUR IMPRINT OR DEEP ETCH
- 1 GIFT BOX

SUPER PACK PROTECTIVE PACKAGING ADD 6.20(G) PER CASE OF 36



RED

GRAY

WHITE

MINT

POWDER BLUE

GIFT BOX

NEW



COLOUR OPTIONS: ● ● ● ●

Emerald

SMOOTHIE & CEREAL BOWL

Start your productive day the right way with this high quality wide ceramic bowl/ mug with handle. Perfect for your favorite homemade smoothie or breakfast cereal. Outside finish is satiny smooth while inside is glossy. Beautiful selection of soft colors will appeal to everyone.

ITEM#: MUG 777

CAPACITY: 25 OZ / 725 ML
 IMPRINT AREA: 4"W X 1"H WRAPAROUND: 10"W X 1"H
 DEEP ETCH AREA: 2.5"W X 1"H

MUG777	72	144	288	SET-UP	REPEAT SET-UP
IMPRINT	8.03	7.79	7.51	65.00	50.00
DEEP ETCH	10.76	10.14	9.51	75.00	60.00

2ND COLOUR: 0.89(C) 5C
 PERSONALIZATION ADD : 4.50(C)
 2ND LOCATION, DEEP ETCH : 6.00(C)

PRICE INCLUDES:

- 1 MUG
- 1 COLOUR IMPRINT OR DEP ETCH
- 1 GIFT BOX

SUPER PACK PROTECTIVE PACKAGING ADD 6.20(G)
 PER CASE OF 36



RED

POWDER BLUE

MINT

GRAY

GIFT BOX



WHITE QUARTZ

TEA & COFFEE MUG

PURE LUXURY

Start your day off right with this stunning coffee mug. The sleek matte white finish with contrasting interior makes the White Quartz coffee mug a cut above the rest. Either at home or the office great coffee should always be enjoyed in style.

ITEM#: MUG772

12(OZ) / 600(ML)
 IMPRINT AREA: 1.75"H X 3"W WRAPAROUND: 7.5"W
 DEEP ETCH AREA: 1.5"H X 3"W

MUG772	72	144	288	SET-UP	REPEAT SET-UP
IMPRINT	10.00	9.69	9.38	65	50
DEEP ETCH	10.38	10.09	9.81	75	60
2ND COLOUR:	0.89(C)				5C
PERSONALIZATION ADD :	4.50(C)				
2ND LOCATION, DEEP ETCH :	6.00(C)				

PRICE INCLUDES:

- 1 MUG
- 1 COLOUR IMPRINT OR DEEP ETCH
- GIFT BOX

SUPER PACK PROTECTIVE PACKAGING ADD 6.20(G) PER CASE OF 36



BLUE

RED

LIME

GRAY

GIFT BOX

HOT CHOCOLATE

-----ONE OF THE LATEST GROWING TRENDS IN DRINKING!

WHY NOT DRINK YOUR "HOT" CHOCOLATE WITH A "HOT" LOOKING MUG!



deep etch decoration position: opposite to handle



GIFT BOX

the **HOT CHOCOLATE** mug

PARISIAN HOT CHOCOLATE

- Four "parisian-sized" servings
- 2 cups (.5l) whole milk
- 5 ounces (130 g) bittersweet chocolate, (best-quality), finely chopped
- optional: 2 tablespoons light brown sugar

1. heat the milk in a medium-sized saucepan.
2. once the milk is warm, whisk in the chocolate, stirring until melted and steaming hot. For a thick hot chocolate, cook at a very low boil for about 3 minutes, whisking constantly. Be careful and keep an eye on the mixture, as it may boil up a bit during the first moments.
3. taste, and add brown sugar if desired.

ITEM#: MUG 440

14(OZ)/400(ML)
DEEP ETCH AREA: 1.25"H X 2"W

ITEM NO.	72	144	288	SET-UP	REPEAT SET-UP
MUG440	13.42	12.3	11.18	75	60

PERSONALIZATION: ADD \$4.50(C) 5C

PRICE INCLUDES:

- 1 "HOT CHOCOLATE MUG"
- 1 DEEP ETCH DECORATION
- 1 GIFT BOX

SUPER PACK PROTECTIVE PACKAGING ADD 6.20(G)
PER CASE OF 36



the **HOT CHOCOLATE** mug set

The Hot Chocolate Mug, our modern ceramic mug with a cheeky chocolate drip meets luxurious and world-renowned Ghirardelli Premium Hot Cocoa... Indulge in the intensely rich chocolate flavor. What better way to face those wintry days! Add marshmallows at will !

*KOSHER - DAIRY

ITEM#: HC/MUG440

14(OZ)/400(ML)
IMPRINT AREA: 1.25"H X 2"W

ITEM NO.	72	144	288	SET-UP	REPEAT SET-UP
HC/MUG440	19.02	12.9	15.66	75	60

PERSONALIZATION: ADD \$4.50(C) 5C

PRICE INCLUDES:

- 1 MUG WITH DEEP ETCH DECORATION
- HOT CHOCOLATE 1.5OZ (43G) & MARSHMALLOWS 0.7OZ (20G)
- GIFT BOX

SUPER PACK PROTECTIVE PACKAGING ADD 6.20(G) PER CASE OF 36



GIFT BOX



the
PORCELAIN
"JEWEL"

COLOUR OPTIONS: ● ● ● ● ●

High quality porcelain
Free flow handle captivating design
Matching glaze on interior and handle
Soft and silky exterior
Matte white exterior
Glazed colour interior



ITEM#: MUG220

12(OZ)/360(ML)
IMPRINT AREA: 2"X 1.25"W
DEEP ETCH AREA: 2"W X 1.25"H

MUG220	72	144	288	SET-UP	REPEAT SET-UP
IMPRINT	8.91	8.66	8.39	65	50
DEEP ETCH	12.59	11.54	10.49	75	60
2ND COLOUR PRINTING :	0.89(C)			5C	
PERSONALIZATION ADD :	4.50(C)				
2ND LOCATION, DEEP ETCH :	6.00(C)				

PRICE INCLUDES:

- 1 "HOT CHOCOLATE MUG"
- 1 COLOUR IMPRINT OR DEEP ETCH
- 1 GIFT BOX

SUPER PACK PROTECTIVE PACKAGING ADD
6.20(G) PER CASE OF 36



IVORY
TOWER *with adjustable lid*

COLOUR OPTIONS: ● ● ● ●

High end porcelain, Soft and silky exterior
Oriental style, Ideal for tea
Outer wall matte white, Inner wall shiny colour



ITEM#: MUG999

12(OZ)/360(ML)
IMPRINT AREA: 2.5"H X 2"W
DEEP ETCH AREA: 2"H X 2"W
WRAPAROUND: 7"

MUG999	72	144	288	SET-UP	REPEAT SET-UP
IMPRINT	11.01	10.76	10.49	65	50
DEEP ETCH	14.69	13.64	12.59	75	60
2ND COLOUR PRINTING :	1.65(C)			5C	
PERSONALIZATION ADD :	4.50(C)				
2ND LOCATION, DEEP ETCH :	6.00(C)				

PRICE INCLUDES:

- 1 MUG
- 1 COLOUR IMPRINT OR DEEP ETCH
- GIFT BOX

SUPER PACK PROTECTIVE PACKAGING ADD
6.20(G) PER CASE OF 36

PURPLE

BROWN



RED

the
PORCELAIN
"SAPPHIRE"

COLOUR OPTIONS: ● ● ● ● ●

THE NEW LOOK IN PORCELAIN

- Free flow handle with silky finish outside and captivating design
- Matching inside and handle body
- High quality porcelain
- Soft and silky exterior
- Dishwasher proof
- 100% bpa free
- Outer wall matte white
- Inner wall shiny colour

ITEM#: MUG330

12(OZ)/360(ML)
IMPRINT AREA: 1.75"H X 1"W

MUG330	72	144	288	SET-UP	REPEAT SET-UP
IMPRINT	9.50	9.23	8.94	65	50
DEEP ETCH	13.42	12.30	11.18	75	60
2ND COLOUR : 0.89(C)					5C
PERSONALIZATION ADD : 4.50(C)					
2ND LOCATION, DEEP ETCH : 6.00(C)					

PRICE INCLUDES:
- 1 MUG WITH 1 COLOUR IMPRINT OR DEEP ETCH
- GIFT BOX

SUPER PACK PROTECTIVE PACKAGING ADD 6.20(G) PER CASE OF 36



GIFT BOX

CHOCOLATE
GEMS *set*

HAVE A FUN TREAT WITH YOUR COFFEE TODAY!

This colorful gift set is a crowd-pleaser, inspired by memories of candy stores and carnivals.

Whether you enjoy them one at a time or by the handful, chocolate gems are impossible to resist. Our Sapphire mug is the perfect match, with its bold look and silky smooth finish. Perfect companions for your daily coffee break.



*Kosher – Dairy
Gluten and Peanut free

COLOUR OPTIONS: ● ● ● ● ●

ITEM#: MUG330/CH

12(OZ)/360(ML)
IMPRINT AREA: 1.75"H X 1"W

MUG330/CH	72	144	288	SET-UP	REPEAT SET-UP
IMPRINT	13.98	13.71	13.41	65	50
DEEP ETCH	17.89	16.77	15.65	75	60
2ND COLOUR : 0.89(C)					5C
PERSONALIZATION ADD : 4.50(C)					
2ND LOCATION, DEEP ETCH : 6.00(C)					

PRICE INCLUDES:
- 1 MUG
- 1 COLOUR IMPRINT OR DEEP ETCH ON 1 SIDE
- GIFT BOX

SUPER PACK PROTECTIVE PACKAGING ADD 6.20(G) PER CASE OF 36



BLUE

YELLOW

PURPLE

BROWN



La Mie Du Pain

Nutritious whole grain bread mix

NUTRITIOUS WHOLE GRAIN, CRANBERRY AND PUMPKIN SEED BREAD MIX

"Bread is the staff of life", and now it's healthy and satisfying too. Packed with tasty cranberries, pumpkin seeds and whole grains, try our one of a kind bread mix. Quick and easy to make, it's great hot out of the oven at dinnertime, or for a healthy breakfast to start your day.

BREAD MADE FROM REAL, NATURALLY SIMPLE INGREDIENTS

Wholesome grain option

Whole wheat flour, enriched flour, cranberries, 9 grain mix (wheat, millet, oat, rye, corn, buckwheat, flax, rice, triticale), whole rolled oats, pumpkin seeds, caraway seeds, baking powder, baking soda, salt. Contains: wheat. Net weight 18.3 oz (520g)

- La Mie Du Pain and Campfire Mug set includes:
- Campfire mug with one color print - 4 color options
 - Whole grain, cranberry and pumpkin seed bread mix in glass jar
 - Gift box

NEW

A Gift of
Healthy Living



COLOUR OPTIONS:

ITEM#: CFM16/MJ

14(OZ) / 420(ML)
IMPRINT AREA: 1.75"H X 2.5"W

ITEM NO.	48	96	144	288	SET-UP	REPEAT SET-UP
CFM16/MJ	23.98	22.06	19.50	18.50	65.00	50.00
2ND COLOUR PRINTING : 1.65(C)						6C
UPGRADE TO DEEP ETCH : 4.50(C)						
PERSONALIZATION ADD : 4.50(C)						

PRICE INCLUDES:

- 1 MUG
- 1 COLOUR IMPRINT ON MUG
- 1 JAR OF BREAD MIX
- 1 GIFT BOX





Paradise Fruit Petites

Bite sized dry fruits and seeds

DISCOVER NATURE'S SWEET, SALTY, CRUNCHY AND CHEWY FRUITS & SEEDS

Snacks are an ever-present part of every busy workday. Why settle for something less than healthy? Layered to please the eye and palate, this delicious selection of energy-packed dried fruits and seeds can power your day or your favorite activity.

HEALTHY DRY FRUITS AND SEEDS ARE A SATISFYING TREAT

2 flavorful options to choose from :

Bananas & more Maple flavored sunflower kernels, pineapple pieces, cranberries, sweet banana chips, Thompson raisins and roasted unsalted pumpkin seeds. Contains: Soya, sulfites

Coconut & more Date pieces, golden raisins, sweet coconut pieces, cranberries, kiwi pieces and roasted unsalted sunflower kernels
Contains: Soya, sulfites

Net weight 11 oz (315g)

Paradise Fruit Petites set includes:
Ceramic mug with one logo print
Glass Jar of dry fruits & seeds selection – 2 options available

NEW



COLOUR OPTIONS: ● ● ● ○ ●

ITEM#: PARA/888

25(OZ) / 725(ML)
IMPRINT AREA: 1" H X 4" W
DEEP ETCH: 1" H X 4" W
WRAPAROUND: 1" H X 10" W

ITEM NO.	48	96	144	288	SET-UP	REPEAT SET-UP
PARA/888	23.98	22.06	19.50	18.50	65.00	50.00
2ND COLOUR PRINTING : 1.65(C)						6C
UPGRADE TO DEEP ETCH : 4.50(C)						
PERSONALIZATION ADD : 4.50(C)						

PRICE INCLUDES:
- 1 MUG WITH 1 COLOUR IMPRINT
- 1 DRY FRUIT/SEEDS JAR
- 1 GIFT BOX





All day Super Oats

Single serve whole grain hot cereal in a bowl

WHOLE GRAIN GOODNESS IN A BOWL

Hot oat cereal is considered one of the best nutrition options today. Filled with wholesome rolled oats, dried fruits, nuts and seeds, no other breakfast option compares to this nutritional powerhouse. Just add hot water and enjoy!

3 hearty options to choose from :

Apple Cinnamon Bliss

Rolled whole grain oats, raisins, apple pieces, almonds, pumpkin seeds, sunflower kernels, cane sugar and cinnamon
Contains: Tree nuts

Heavenly Blueberry & Chocolate

Rolled whole grain oats, blueberries, chocolate, almonds, pumpkin seeds, sunflower kernels, cane sugar
Contains: Tree nuts, milk

Cranberry Coconut Dream

Rolled whole grain oats, cranberries, raisins, almonds, pumpkin seeds, sunflower kernels, cane sugar, coconut flakes
Contains: Tree nuts

Net weight 2.4oz (68g)

NEW



COLOUR OPTIONS: ● ● ● ●

ITEM#: SO/777

25(OZ) / 725(ML)
IMPRINT AREA: 1"H X 4"W
DEEP ETCH: 1"H X 4"W
WRAPAROUND: 1"H X 10"W

All day super oats and cereal bowl set includes:
cereal mug with one color print – 4 color options
2 – all day super oats cereal packets – 3 tasty flavors

ITEM NO.	48	96	144	288	SET-UP	REPEAT SET-UP
SO/777	23.98	22.06	19.50	18.50	65.00	50.00
2ND COLOUR PRINTING : 1.65(C)						6C
UPGRADE TO DEEP ETCH : 4.50(C)						
PERSONALIZATION ADD : 4.50(C)						

PRICE INCLUDES:
- 1 MUG WITH 1 COLOUR IMPRINT
- 1 DRY FRUIT/SEEDS JAR
- 1 GIFT BOX



3 CEREAL OPTIONS

GIFT BOX



POWDER BLUE

MINT

GRAY

RED



Bright festive colours

SPARKLING MUG

COLOUR OPTIONS: ● ● ● ● ●

These high gloss, polished and plated mugs shimmer with intense sparkling colors
Ideal for hot chocolate and other festive beverages
hand wash only!



ITEM#: MUG550

14(OZ)/400(ML)
IMPRINT AREA: 1.25"H X 1.25"W

ITEM NO.	72	144	288	SET-UP	REPEAT SET-UP
MUG550	11.18	10.62	10.06	65	50
1 COLOUR IMPRINT ON 1 SIDE ONLY					5C
SUPER PACK PROTECTIVE PACKAGING ADD 6.20(G) PER CASE OF 36					

PRICE INCLUDES:
- 1 MUG
- 1 COLOUR IMPRINT
- GIFT BOX



EPM 1

EPM 3

EPM 4

EPM 2

the ESPRESSO coffee cup

INDIVIDUAL CERAMIC ESPRESSO CUPS

Enjoy the world's favorite coffee that comes in the smallest cup: Espresso!
Coffee lovers are becoming more invested than ever before in this specialty brew:
It's quality, it's status and of course, it's distinctive cup size. Choice of four distinctive models, choose one or a mix.
Includes one logo print or deep etch

BLACK MATTE OUTSIDE/GLOSSY INSIDE: ●

ITEM#: EPM1/EPM2/EPM3/EPM4

CAPACITY	IMPRINT AREA	DEEP ETCH AREA
EPM1 3.3OZ/100ML	1.25" W X 1.25" H	1" W X 1" H
EPM2 3.7OZ/110ML	1.25" W X 1" H	1" W X 0.75" H
EPM3 4OZ/112ML	1.25" W X 1.5" H	1" W X 1.5" H
EPM4 3.3OZ/100ML	1" W X 0.75" H	0.75" W X 0.5" H

ITEM NO.	72	144	288	SET-UP	REPEAT SET-UP
EPM1/EPM2/EPM3/EPM4	4.7	4.32	3.74	65	50
PERSONALIZATION ADD : 4.50(C)					5C
2ND LOCATION, DEEP ETCH: 6.00(C)					

PRICE INCLUDES:
- 1 MUG
- TONE ON TONE IMPRINT OR DEEP ETCH
- GIFT BOX



THE PEARL *Printed Decoration*

ITEM #: MUG770

14(OZ)/420(ML)
 IMPRINT AREA: 1.75"H X 2"W
 WT/PACK/CASE: 36CTN/44LBS

ITEM NO.	72	144	288	SET-UP	REPEAT SET-UP
MUG770 (SINGLE)	7.98	7.73	7.45	65.00	50.00
MUG770 (SET OF 2)	15.45	14.92	14.38	65.00	50.00

2ND COLOUR: 0.89(C)/PC 1.78(C)/SET(C) 5C
 SUPER PACK PROTECTIVE PACKAGING ADD 6.20 (G) PER CASE OF 36

PRICE INCLUDES: - MUG WITH 1 COLOR PRINT
 - PLAIN WHITE BOX FOR 1 OR 2 PCS.

TONE ON TONE
 - THE NEW LOOK IN PRINTING
 "WHERE LESS IS MORE"

COLOUR OPTIONS: ● ● ● ● ○



WHITE GREEN BLUE



THE PEARL *Deep Etch Decoration*

ITEM #: MUG770

14(OZ)/420(ML)
 IMPRINT AREA: 1.75"H X 2"W
 WT/PACK/CASE: 36CTN/44LBS

ITEM NO.	72	144	288	SET-UP	REPEAT SET-UP
MUG770 (SINGLE)	10.65	10.12	9.58	75.00	60.00
MUG770 (SET OF 2)	21.31	20.24	19.17	75.00	60.00

2ND LOCATION: \$6.00(C) 5C
 PERSONALIZATION: \$4.50(C)
 SUPER PACK PROTECTIVE PACKAGING ADD 6.20 (G) PER CASE OF 36

PRICE INCLUDES: - MUG WITH DEEP ETCH ON 1 SIDE
 - PLAIN WHITE BOX FOR 1 OR 2 PCS.

COLOUR OPTIONS: ● ● ● ● ○



WHITE BLACK BLUE



RED



BLUE

The **BLACK PEARL** Printed Decoration

ITEM#: BP01

14(OZ)/420(ML)
 IMPRINT AREA: 1.75"H X 2.5"W
 WT/PACK/CASE: 36CTN/44LBS

ITEM NO.	72	144	288	SET-UP	REPEAT SET-UP
BPO1 (SINGLE)	8.38	8.11	7.82	65.00	50.00
BPO1 (SET OF 2)	16.21	15.66	15.1	65.00	50.00

2ND COLOUR: 0.89(C)/PC 1.78(C)/SET(C) 5C
 SUPER PACK PROTECTIVE PACKAGING ADD 6.20 (G) PER CASE OF 36

PRICE INCLUDES: - MUG WITH 1 COLOR PRINT
 - TONE ON TONE BOX FOR 1, WHITE BOX FOR 2

TONE ON TONE
 - THE NEW LOOK IN PRINTING
 "WHERE LESS IS MORE"

COLOUR OPTIONS: ● ● ● ● ● ●



BROWN

SKY BLUE

HUNTER GREEN

LIME



BROWN



The **BLACK PEARL** Deep Etch Decoration

ITEM#: BP01

14(OZ)/420(ML)
 IMPRINT AREA: 1.75"H X 2.5"W
 WT/PACK/CASE: 36CTN/44LBS

ITEM NO.	72	144	288	SET-UP	REPEAT SET-UP
BPO1 (SINGLE)	11.18	10.62	10.06	75.00	60.00
BPO1 (SET OF 2)	22.37	21.26	20.13	75.00	60.00

2ND LOCATION: \$6.00(C)
 PERSONALIZATION: \$4.50(C)
 SUPER PACK PROTECTIVE PACKAGING ADD 6.20 (G) PER CASE OF 36

PRICE INCLUDES: - MUG WITH DEEP ETCH ON 1 SIDE
 - TONE ON TONE BOX FOR 1, WHITE BOX FOR 2

COLOUR OPTIONS: ● ● ● ● ● ●



RED

BLUE

SKY BLUE

HUNTER GREEN

LIME



COBALT
DEEP ETCH



ORANGE
PRINTING



BOX FOR 1

BOX FOR 2



BROWN
DEEP ETCH

RED
TONE ON TONE



BOX FOR 1

BOX FOR 2

The "PRECIOUS" STONEWARE

ITEM#: SI150

12(OZ)/360(ML)
IMPRINT AREA: 2"H X 2.5"W
WRAPAROUND: 7.5"
WT/PACK/CASE: 36CTN/28.6LBS

COLOUR OPTIONS:



YELLOW

ORANGE

LIME

COBALT

RED

BLACK

PRINT

ITEM NO.	72	144	288	SET-UP	REPEAT SET-UP
SI150 (SINGLE)	8.38	8.11	7.82	65.00	50.00
SI150 (SET OF 2)	16.21	15.66	15.1	65.00	50.00

2ND COLOUR: 0.89(C)/PC 1.78(C)/SET(C) 5C
SUPER PACK PROTECTIVE PACKAGING ADD 6.20 (G) PER CASE OF 36

PRICE INCLUDES: - MUG WITH 1 COLOR PRINT
- PLAIN WHITE BOX FOR 1 OR 2 PCS.

DEEP ETCH

ITEM NO.	72	144	288	SET-UP	REPEAT SET-UP
SI150 (SINGLE)	11.18	10.62	10.06	75.00	60.00
SI150 (SET OF 2)	22.37	21.26	20.13	75.00	60.00

2ND LOCATION: \$6.00(C) 5C
PERSONALIZATION: \$4.50(C)
SUPER PACK PROTECTIVE PACKAGING ADD 6.20 (G) PER CASE OF 36
PRICE INCLUDES: - MUG WITH DEEP ETCH ON 1 SIDE
- PLAIN WHITE BOX FOR 1 OR 2 PCS.

The BLACK ONYX MUG

ITEM#: MUG880

12(OZ)/360(ML)
IMPRINT AREA: 1.5"H X 2.5"W
WT/PACK/CASE: 36CTN/44LBS

COLOUR OPTIONS:



RED

BLUE

BROWN

WHITE

PRINT

ITEM NO.	72	144	288	SET-UP	REPEAT SET-UP
MUG880 (SINGLE)	8.52	7.98	7.45	65.00	50.00
MUG880 (SET OF 2)	17.05	15.98	14.92	65.00	50.00

2ND COLOUR: 0.89(C)/PC 1.78(C)/SET(C) 5C
SUPER PACK PROTECTIVE PACKAGING ADD 6.20 (G) PER CASE OF 36

PRICE INCLUDES: - MUG WITH 1 COLOR PRINT
- PLAIN WHITE BOX FOR 1 OR 2 PCS.

DEEP ETCH

ITEM NO.	72	144	288	SET-UP	REPEAT SET-UP
MUG880 (SINGLE)	11.18	10.62	10.06	75.00	60.00
MUG880 (SET OF 2)	22.37	21.26	20.13	75.00	60.00

2ND LOCATION: \$6.00(C) 5C
PERSONALIZATION: \$4.50(C)
SUPER PACK PROTECTIVE PACKAGING ADD 6.20 (G) PER CASE OF 36
PRICE INCLUDES: - MUG WITH DEEP ETCH ON 1 SIDE
- PLAIN WHITE BOX FOR 1 OR 2 PCS.



"GOOD MORNING" MUG

ITEM#: BL890

10(OZ)/300(ML)
 IMPRINT AREA: 1.75"H X 2"W
 WRAPAROUND: 7.5"W
 WT/PACK/CASE: 36CTN/38LBS

PRINT

ITEM NO.	72	144	504	SET-UP	REPEAT SET-UP
BL890	8.68	7.82	7.26	65.00	50.00

2ND COLOUR: 0.89(C)/PC 1.78(C)/SET(C) 5C
 UPDGRADE TO DEEP ETCH LOGO: \$4.50(C)
 2ND LOCATION: \$6.00(C)
 PERSONALIZATION: \$4.50(C)
 SUPER PACK PROTECTIVE PACKAGING ADD 6.20 (G) PER CASE OF 36

COLOUR OPTIONS: ○ ● ●



WHITE COBALT BLACK

PRICE INCLUDES: - MUG WITH 1 COLOR PRINT OR DEEP ETCH

COASTER MUG Set

ITEM#: SI 900

12(OZ)/360(ML)
 IMPRINT AREA: 2"H X 2.5"W
 WRAPAROUND: 7"W
 WT/PACK/CASE: 36CTN/37LBS

COLOUR OPTIONS: ● ● ● ● ● ● ●



RED ORANGE BLUE LIME BLACK COBALT

PRINT

ITEM NO.	72	144	504	SET-UP	REPEAT SET-UP
SI900	8.8	8.56	8.22	65.00	50.00

2ND COLOUR: 0.89(C)/PC 5C
 UPDGRADE TO DEEP ETCH LOGO: \$4.50(C)
 2ND LOCATION: \$6.00(C)
 PERSONALIZATION: \$4.50(C)
 SUPER PACK PROTECTIVE PACKAGING ADD 6.20 (G) PER CASE OF 36

PRICE INCLUDES:
 - MUG WITH 1 COLOR PRINT OR DEEP ETCH



"ROCK OF GIBRALTAR" MUG

ITEM#: SI7100

10(OZ)/300(ML)
 IMPRINT AREA: 1.5"H X 2.25"W
 WRAPAROUND: 7.5"W

PRINT

ITEM NO.	72	144	504	SET-UP	REPEAT SET-UP
SI7100	7.97	7.61	7.23	65.00	50.00

2ND COLOUR: 0.89(C)/PC 1.78(C)/SET(C) 5C
 UPDGRADE TO DEEP ETCH LOGO: \$4.50(C)
 2ND LOCATION: \$6.00(C)
 PERSONALIZATION: \$4.50(C)
 SUPER PACK PROTECTIVE PACKAGING ADD 6.20 (G) PER CASE OF 36

COLOUR OPTIONS: ●●●●●○



PRICE INCLUDES:
 - MUG WITH 1 COLOR PRINT OR DEEP ETCH

"CHALK BOARD" MUG

ITEM#: JC CHALK

12(OZ)/360(ML)
 IMPRINT AREA: 2.25"H X 2.5"W
 WT/PACK/CASE: 36CTN/33LBS

PRINT

ITEM NO.	72	144	504	SET-UP	REPEAT SET-UP
WHITE	8.11	7.66	7.23	65.00	50.00
WHITE/RED	9.35	8.9	8.46	65.00	50.00

2ND COLOUR: 0.89(C)/PC 1.78(C)/SET(C) 5C
 UPDGRADE TO DEEP ETCH LOGO: \$4.50(C)
 2ND LOCATION: \$6.00(C)
 PERSONALIZATION: \$4.50(C)
 SUPER PACK PROTECTIVE PACKAGING ADD 6.20 (G) PER CASE OF 36

COLOUR OPTIONS: ○●
 WHITE/RED 2 TONE



PRICE INCLUDES:
 - MUG WITH PRINT OR DEEP ETCH
 - 1 SIDE CHALK BOARD SURFACE
 - 1 PIECE WHITE CHALK



DOUBLE WALL

Porcelain Mug with Silicone Lid

COLOUR OPTIONS: ● ● ● ● ● ● ● ●

ITEM#: DWCO8

8(OZ)/240(ML)
 HEIGHT: 8.85"H
 IMPRINT AREA: 4"H X 2.25"W
 WT/PACK/CASE: 24CTN/30LBS



CHOCOLATE BLACK WHITE YELLOW BLACK/WHITE BLUE PINK RED

PRINT

ITEM NO.	72	144	504	SET-UP	REPEAT SET-UP
DWCO8	8.62	8.46	8.22	65.00	50.00

2ND COLOUR: 0.89(C)/PC
 UPDGRADE TO DEEP ETCH LOGO: \$4.50(C)
 2ND LOCATION: \$6.00(C)
 PERSONALIZATION: \$4.50(C)
 SUPER PACK PROTECTIVE PACKAGING ADD 6.20 (G) PER CASE OF 24

PRICE INCLUDES:

- DOUBLE WALL MUG WITH PRINT (SILICONE LID)
- 1 WHITE BOX



THERMO STEEL

ITEM#: CS14

14(OZ)/450(ML)
 IMPRINT AREA: 3"H X 3"W
 WRAPAROUND: 11.5"W

PRICE INCLUDES:

- 1 THERMO STEEL WITH PRINT
- 1 WHITE BOX

STAINLESS STEEL AND CERAMIC TUMBLER

Stainless steel exterior
 Rubber liner for insulation
 Ceramic interior
 Ceramic lid
 Satin finish exterior

High quality travel mug, has great looks and keeps drinks hot

COLOUR OPTIONS: ● ● ● ●



GUN METAL SILVER FUCHSIA COPPER WHITE BOX

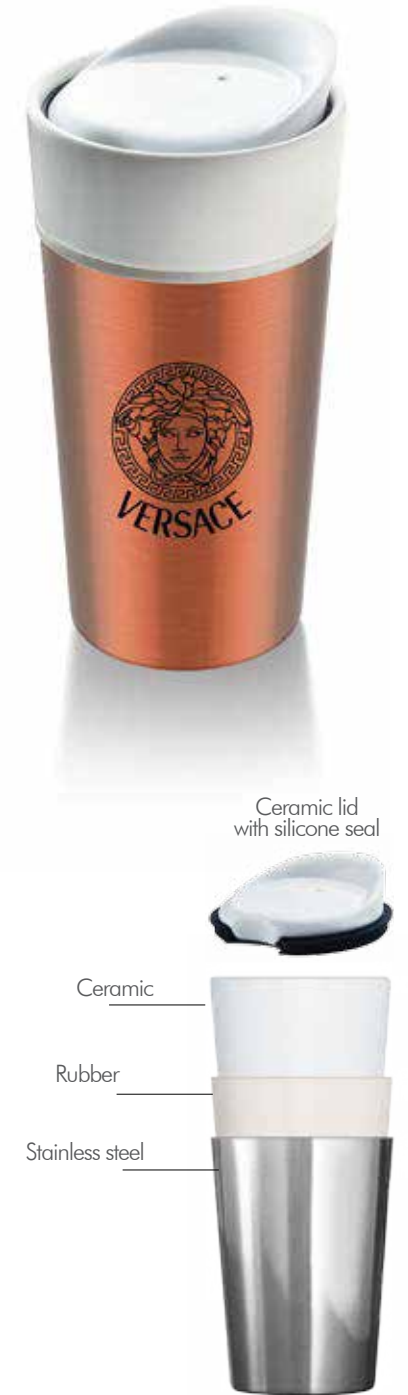

PRINT

ITEM NO.	72	144	504	SET-UP	REPEAT SET-UP
CS14	20.14	19.02	17.9	65.00	50.00

2ND COLOUR: 0.89(C)/PC
 UPGRADE TO DIAMOND ENGRAVING: \$4.50(C)
 2ND LOCATION: \$6.00(C)
 PERSONALIZATION: \$4.50(C)
 SUPER PACK PROTECTIVE PACKAGING ADD 6.20 (G) PER CASE OF 24



COBALT/WHITE
DEEP ETCH DECORATION



COBALT/WHITE
PEWTER DECORATION



ORANGE
PRINTING DECORATION



LIME
DEEP ETCH DECORATION



RED
PEWTER DECORATION

COUNTRY STYLE MUG

COLOUR OPTIONS: ● ○ ● ● ●



ITEM#: MUG590

16(OZ)/480(ML)
IMPRINT AREA: 2"H X 2.75"W
WRAPAROUND: 7.5"
WT/PACK/CASE: 36CTN/44 LBS

PRINT

ITEM NO.	72	144	504	SET-UP	REPEAT SET-UP
MUG590	7.15	6.47	6.31	65.00	50.00

2ND COLOUR: 0.89(C)/PC 5C
SUPER PACK PROTECTIVE PACKAGING ADD 6.20 (G) PER CASE OF 36
PRICE INCLUDES:
- MUG WITH PRINT

DEEP ETCH

ITEM NO.	72	144	288	SET-UP	REPEAT SET-UP
MUG590	13.12	12.49	11.86	75.00	60.00

2ND LOCATION: \$6.00(C) 5C
PERSONALIZATION: \$4.50(C)
SUPER PACK PROTECTIVE PACKAGING ADD 6.20 (G) PER CASE OF 36
PRICE INCLUDES:
- MUG WITH PRINT WITH DEEP ETCH
- BLACK GIFT BOX AND PAPER WRAP

HOUR GLASS MUG

COLOUR OPTIONS: ● ● ● ● ● ● ●



ITEM#: SI340

10(OZ)/300(ML)
IMPRINT AREA: 1"H X 2"W
WRAPAROUND: 7.5"

PRINT

ITEM NO.	72	144	504	SET-UP	REPEAT SET-UP
SI340	8.3	7.3	7.05	65.00	50.00

1 COLOR PRINT ON 1 SIDE ONLY 5C
SUPER PACK PROTECTIVE PACKAGING ADD 6.20 (G) PER CASE OF 36
PRICE INCLUDES:
- MUG WITH PRINT

DEEP ETCH

ITEM NO.	72	144	288	SET-UP	REPEAT SET-UP
SI340	12.59	11.73	11.26	75.00	60.00

2ND LOCATION: \$6.00(C) 5C
PERSONALIZATION: \$4.50(C)
SUPER PACK PROTECTIVE PACKAGING ADD 6.20 (G) PER CASE OF 36
PRICE INCLUDES:
- MUG WITH PRINT WITH DEEP ETCH
- BLACK GIFT BOX AND PAPER WRAP



WHITE
DEEP ETCH DECORATION

RED
PRINTING DECORATION

LIME
PEWTER DECORATION



RED
DEEP ETCH DECORATION

LIME
PRINTING DECORATION



BLUE
PEWTER DECORATION



BIG GULP MUG

COLOUR OPTIONS: ● ○ ● ● ● ● ● ● ● ●



ITEM#: M376

14(OZ)/420(ML)
IMPRINT AREA: 1.75"H X 2.5"W
WRAPAROUND: 7.75"
WT/PACK/CASE: 36CTN/36LBS

PRINT

ITEM NO.	72	144	504	SET-UP	REPEAT SET-UP
MUG376	7.01	6.58	6.41	65.00	50.00

2ND COLOUR: 0.89(C)/PC 5C
SUPER PACK PROTECTIVE PACKAGING ADD 6.20 (G) PER CASE OF 36
PRICE INCLUDES:
- MUG WITH PRINT

DEEP ETCH

ITEM NO.	72	144	288	SET-UP	REPEAT SET-UP
MUG376	11.92	11.36	10.77	75.00	60.00

2ND LOCATION: \$6.00(C)
PERSONALIZATION: \$4.50(C)
SUPER PACK PROTECTIVE PACKAGING ADD 6.20 (G) PER CASE OF 36
PRICE INCLUDES:
- MUG WITH PRINT WITH DEEP ETCH
- BLACK GIFT BOX AND PAPER WRAP

TWO TONE MUG

COLOUR OPTIONS: ● ● ● ● ○



ITEM#: M168

12(OZ)/360(ML)
IMPRINT AREA: 2"H X 2.5"W
WRAPAROUND: 7.5"
WT/PACK/CASE: 36CTN/33LBS

PRINT

ITEM NO.	72	144	504	SET-UP	REPEAT SET-UP
MUG168	7.32	6.8	6.28	65.00	50.00

2ND COLOUR: 0.89(C)/PC 5C
SUPER PACK PROTECTIVE PACKAGING ADD 6.20 (G) PER CASE OF 36
PRICE INCLUDES:
- MUG WITH PRINT

DEEP ETCH

ITEM NO.	72	144	288	SET-UP	REPEAT SET-UP
MUG168	11.36	10.81	10.26	75.00	60.00

2ND LOCATION: \$6.00(C)
PERSONALIZATION: \$4.50(C)
SUPER PACK PROTECTIVE PACKAGING ADD 6.20 (G) PER CASE OF 36
PRICE INCLUDES:
- MUG WITH PRINT WITH DEEP ETCH
- BLACK GIFT BOX AND PAPER WRAP



BRIGHT RED

GREEN

COBALT

TRIM TONE MUG

ITEM#: PM5

12(OZ)/355(ML)
 IMPRINT AREA: 1.5"H X 2.5"W
 WRAPAROUND: 7.5"
 WT/PACK/CASE: 36CTN/38LBS

PRINT

ITEM NO.	72	144	504	SET-UP	REPEAT SET-UP
PM5-COBALT, BLACK, GREEN, MAROON	7.32	6.8	6.8	65.00	50.00
PM5-RED	8.38	7.36	7.32	65.00	50.00

2ND COLOUR: 0.89(C)/PC 5C
 SUPER PACK PROTECTIVE PACKAGING ADD 6.20 (G) PER CASE OF 36

PRICE INCLUDES:
 - MUG WITH PRINT

COLOUR OPTIONS: ● ● ● ● ● ●



RED

GREEN

BLACK

MAROON

DEEP ETCH

ITEM NO.	72	144	504	SET-UP	REPEAT SET-UP
PM5-COBALT, BLACK, GREEN, MAROON	10.22	10.05	9.72	75.00	60.00
PM5-RED	11.46	10.99	10.06	75.00	60.00

2ND LOCATION: \$6.00(C) 5C
 PERSONALIZATION: \$4.50(C)
 SUPER PACK PROTECTIVE PACKAGING ADD 6.20 (G) PER CASE OF 36
 PRICE INCLUDES:
 - MUG WITH PRINT WITH DEEP ETCH
 - BLACK GIFT BOX AND PAPER WRAP



COBALT
 DEEP ETCH DECORATION



WHITE
 PRINTING DECORATION



BLACK
 PEWTER DECORATION

FUNNEL MUG

ITEM#: PM 8

12(OZ)/355(ML)
 IMPRINT AREA: 1.75"H X 2.5"W
 WRAPAROUND: 7.5"
 WT/PACK/CASE: 36CTN/33LBS

PRINT

ITEM NO.	72	144	504	SET-UP	REPEAT SET-UP
PM8-WHITE	5.56	5.33	5.08	65.00	50.00
PM8-BLACK	5.7	5.43	5.2	65.00	50.00
PM8-COBALT	6.04	5.81	5.57	65.00	50.00

2ND COLOUR: 0.89(C)/PC 5C
 SUPER PACK PROTECTIVE PACKAGING ADD 6.20 (G) PER CASE OF 36
 PRICE INCLUDES:
 - MUG WITH PRINT

COLOUR OPTIONS: ○ ● ●



WHITE

BLACK

COBALT

DEEP ETCH

ITEM NO.	72	144	288	SET-UP	REPEAT SET-UP
PM8-WHITE	10.85	10.36	10	75.00	60.00
PM8-BLACK	11.81	12.1	10.61	75.00	60.00
PM8-COBALT	12.46	11.62	11.16	75.00	60.00

2ND LOCATION: \$6.00(C) 5C
 PERSONALIZATION: \$4.50(C)
 SUPER PACK PROTECTIVE PACKAGING ADD 6.20 (G) PER CASE OF 36
 PRICE INCLUDES:
 - MUG WITH PRINT WITH DEEP ETCH
 - BLACK GIFT BOX AND PAPER WRAP



BLACK
PEWTER DECORATION



BLACK
PEWTER DECORATION



RED
DEEP ETCH DECORATION



RED
DEEP ETCH DECORATION



WHITE
PRINTING DECORATION

WESTERN MUG

COLOUR OPTIONS: ● ○ ● ● ●



BLACK

WHITE

RED

COBALT

ITEM#: PM6

14(OZ)/414(ML)
IMPRINT AREA: 1.75"H X 2.5"W
WRAPAROUND: 7.75"
WT/PACK/CASE: 36CTN/36LBS

PRINT

ITEM NO.	72	144	504	SET-UP	REPEAT SET-UP
PM6-WHITE	5.65	5.32	4.71	65.00	50.00
PM6-BLACK/COBALT	6.03	5.69	5.46	65.00	50.00
PM6-RED	7.2	6.67	6.44	65.00	50.00

2ND COLOUR: 0.89(C)/PC 5C
SUPER PACK PROTECTIVE PACKAGING ADD 6.20 (G) PER CASE OF 36
PRICE INCLUDES:
- MUG WITH PRINT

DEEP ETCH

ITEM NO.	72	144	288	SET-UP	REPEAT SET-UP
PM6-WHITE	12.49	12.51	12.03	75.00	60.00
PM6-BLACK/COBALT	12.86	11.73	11.28	75.00	60.00
PM6-RED	14.09	13.07	11.78	75.00	60.00

2ND LOCATION: \$6.00(C) 5C
PERSONALIZATION: \$4.50(C)
SUPER PACK PROTECTIVE PACKAGING ADD 6.20 (G) PER CASE OF 36
PRICE INCLUDES:
- MUG WITH PRINT WITH DEEP ETCH
- BLACK GIFT BOX AND PAPER WRAP

"C" HANDLE MUG

COLOUR OPTIONS: ○ ● ● ● ●



WHITE

RED

RED/WHITE

COBALT

BLACK

ITEM#: JC108

12(OZ)/360(ML)
IMPRINT AREA: 2.25"H X 2.5"W
WRAPAROUND: 7.5"
WT/PACK/CASE: 36CTN/33LBS

PRINT

ITEM NO.	72	144	504	SET-UP	REPEAT SET-UP
JC108-WHITE	3	2.91	2.67	65.00	50.00
JC108-BLACK/COBALT	4.43	4.18	3.79	65.00	50.00
JC108-RED/RED WHITE	5.96	5.94	5.69	65.00	50.00

2ND COLOUR: 0.89(C)/PC 5C
SUPER PACK PROTECTIVE PACKAGING ADD 6.20 (G) PER CASE OF 36
PRICE INCLUDES:
- MUG WITH PRINT

DEEP ETCH

ITEM NO.	72	144	288	SET-UP	REPEAT SET-UP
JC108-WHITE	8.1	7.61	7.18	75.00	60.00
JC108-BLACK/COBALT	9.48	8.97	8.6	75.00	60.00
JC108-RED	10.67	10.2	9.71	75.00	60.00
JC108-RED/RED WHITE	10.82	10.35	9.87	75.00	60.00

2ND LOCATION: \$6.00(C) 5C
PERSONALIZATION: \$4.50(C)
SUPER PACK PROTECTIVE PACKAGING ADD 6.20 (G) PER CASE OF 36
PRICE INCLUDES:
- MUG WITH PRINT WITH DEEP ETCH
- BLACK GIFT BOX AND PAPER WRAP



BLACK
PEWTER DECORATION

WHITE
PRINTING DECORATION



COBALT
DEEP ETCH DECORATION

JUMBO "C" HANDLE MUG

ITEM#: JC107

14(OZ)/520(ML)
IMPRINT AREA: 2.5"H X 2.5"W
WRAPAROUND: 7.5"
WT/PACK/CASE: 36CTN/46LBS

COLOUR OPTIONS:



WHITE

BLACK

COBALT

DEEP ETCH

ITEM NO.	72	144	288	SET-UP	REPEAT SET-UP
JC107-WHITE	10.56	9.69	9.38	75.00	60.00
JC1074-BLACK/COBALT	10.61	10.14	9.01	75.00	60.00

2ND LOCATION: \$6.00(C)
PERSONALIZATION: \$4.50(C)
SUPER PACK PROTECTIVE PACKAGING ADD 6.20 (G) PER CASE OF 36
PRICE INCLUDES:
- MUG WITH PRINT WITH DEEP ETCH
- BLACK GIFT BOX AND PAPER WRAP

PRINT

ITEM NO.	72	144	288	SET-UP	REPEAT SET-UP
JC107-WHITE	5.39	5.14	4.92	65.00	50.00
JC107-BLACK/COBALT	5.39	5.29	5.06	65.00	50.00

2ND COLOUR: 0.89(C)/PC
SUPER PACK PROTECTIVE PACKAGING ADD 6.20 (G) PER CASE OF 36
PRICE INCLUDES:
- MUG WITH PRINT

SWEET & COZY MUG

PERK UP A COLD WINTER DAY!

ITEM#: SNC 2

MINI MARSHMALLOWS

12 OZ / 355 ML
IMPRINT AREA: 2.25"H X 2.25"W
WRAPAROUND: 7.5"W
WT/PACK/CASE: 36CTN/33LBS

PRINT

ITEM NO.	72	144	504	SET-UP	REPEAT SET-UP
SNC2	12.3	11.7	11.07	65.00	50.00

2ND COLOUR: 0.89(C)/PC
UPGRADE TO DEEP ETCH: \$4.50(C)
2ND LOCATION: \$6.00(C)
PERSONALIZATION: \$4.50(C)
SUPER PACK PROTECTIVE PACKAGING ADD 6.20 (G) PER CASE OF 24
PRICE INCLUDES:
- MUG WITH PRINT
- NIMI MARSHMALLOWS
- GIFT PACKAGING



MINI MARSHMALLOWS
MADE IN USA

CHOC OHOLIC CAKE MUG

JUST ADD WATER AND MICROWAVE EVERYTHING YOU NEED TO ENJOY A CAKE IN A MUG!

- Mug
- Cake mix (Vanilla or Chocolate)
- Chocolate chip topping

ITEM#: CAKE-JC108

12 OZ / 360 ML
IMPRINT AREA: 2.25"H X 2.5"W
WRAPAROUND: 7.5"W
WT/PACK/CASE: 36CTN/33LBS

COLOUR OPTIONS:

PRINT

ITEM NO.	72	144	504	SET-UP	REPEAT SET-UP
CAKE JC108	15.4	14.16	13.54	65.00	50.00

2ND COLOUR: 0.89(C)/PC
UPGRADE TO DEEP ETCH: \$4.50(C)
2ND LOCATION: \$6.00(C)
PERSONALIZATION: \$4.50(C)
SUPER PACK PROTECTIVE PACKAGING ADD 6.20 (G) PER CASE OF 24
PRICE INCLUDES:
- MUG WITH PRINT
- CAKE MIX (VANILLA OR CHOCOLATE)
- CHOCOLATE CHI TOPPING



AVAILABLE IN CANADA ONLY
CAKE MIX MADE IN CANADA

ITEM#: HC-PM6 RED

14 OZ / 420 ML
IMPRINT AREA: 1.5"H X 2"W
WRAPAROUND: 7.5"W
WT/PACK/CASE: 36CTN/33LBS

PRINT

ITEM NO.	72	144	504	SET-UP	REPEAT SET-UP	PRICE INCLUDES:
HC-PM6 RED	14.77	13.53	12.3	65.00	50.00	- MUG WITH PRINT - HOT CHOCOLATE - MARSHMALLOWS - GIFT PACKAGING

2ND COLOUR: 0.89(C)/PC
UPGRADE TO DEEP ETCH: \$4.50(C)
2ND LOCATION: \$6.00(C)
PERSONALIZATION: \$4.50(C)
SUPER PACK PROTECTIVE PACKAGING ADD 6.20 (G) PER CASE OF 24



GLEN CAIRN

Scotch Taster set



WHISKY TASTER WITH STAINLESS STEEL ICE BALL WITH FREEZING GEL

ITEM#: ICE56

7 OZ / 210ML
IMPRINT AREA: 0.5"H X 3"W

PRINT

ITEM NO.	72	144	SET-UP	REPEAT SET-UP
ICE56	18.97	16	65.00	50.00
2ND COLOUR:	0.89(C)		4C	
UPDGRADE TO DEEP ETCH LOGO:	\$4.50(C)			
2ND LOCATION:	\$6.00(C)			
PERSONALIZATION:	\$4.50(C)			

PRICE INCLUDES:
- 1 WHISKY GLASS WITH
- 1 COLOUR IMPRINT/DEEP ETCH
- STAINLESS STEEL ICE BALL
- GIFT BOX



GIFT BOX



The WHITE ICE Whisky stones

THESE WHISKY STONES ARE MADE OF HI-TECH CERAMIC.

Why choose the ceramic whisky stone?

1. Ice melts and it will thin out the whisky, white ice will cool and keep the original flavor.
2. White ice can be recycled.
3. White ice stones cool down the whisky much quicker than regular ice.
4. The tough surface of ceramic whisky stones makes it easy to be cleaned.

How to use ceramic whisky stone?

1. Place them in the freezer for few hours.
2. Add a couple into whisky or other beverage.
3. Wait for a few minutes and enjoy it.



ITEM#: WHITE ICE
IMPRINT AREA: 0.5"H X 0.5"W

PRINT

ITEM NO.	60	140	280	500	SET-UP	REPEAT SET-UP
WHITE ICE	12.88	12.21	11.76	11.18	65.00	50.00

LASER ETCH OPTION: ADD 0.95(C) PER STONE 6C

PRICE INCLUDES:
- 9 WHITE ICE STONES UNDECORATED
- MESH BAG
- GIFT BOX

ARCTIC ICE BALL Whisky Set

WHISKEY ICE BALL : HAS MORE VOLUME AND LESS SURFACE AREA THAN A TRADITIONAL ICE CUBE, SO IT MELTS SLOWER. BRING THE ARTESIAN SCIENCE OF SLOW MELTING ICE SPHERES TO YOUR DRINK. THE WHISKEY BALL MOLD IS DISHWASHER SAFE, BPA FREE, AND READY TO COCKTAIL.



Gift Box

ITEM#: AW/2SET

10 OZ / 300 ML
ETCH AREA: 1.5"H X 2.25"W

PRINT

ITEM NO.	144	SET-UP	REPEAT SET-UP
AW/2SET	11.07	65.00	50.00
2ND COLOUR:	0.89(C)		3C
UPDGRADE TO DEEP ETCH LOGO:	\$4.50(C)		
2ND LOCATION:	\$6.00(C)		
PERSONALIZATION:	\$4.50(C)		

PRICE INCLUDES:
- 1 WHISKY GLASS WITH
- 1 COLOUR IMPRINT/DE
- 1 SILICONE IC
- GIFT BOX





CHAMPAGNE GLASS Selection



DCH-204 (5¼OZ / 167ML) IMP.AREA: 1.5"H X 1¼"W WRAP.AROUND: 6"W
 DCH-203 (8OZ / 232ML) IMP.AREA: 1.5"H X 1¼"W WRAP.AROUND: 6¼"W
 LCH-103 (5¼OZ / 167ML) IMP.AREA: 1.5"H X 1¾"W WRAP.AROUND: 6"W
 DCH-800 (5¼OZ / 172.5ML) IMP.AREA: 1.5"H X 1¼"W WRAP.AROUND: 6¼"W

PRINT

ITEM NO.	72	144	504	1440	SET-UP	REPEAT SET-UP
DCH-204	6.28	6.03	5.9	5.66	65.00	50.00
DCH-203	7.45	7.28	6.83	6.61	65.00	50.00
LCH-103	8.46	6.57	6.27	5.51	65.00	50.00
DCH-800	8.88	7.9	7.33	6.83	65.00	50.00

2ND COLOUR: 0.89(C) 6C

PRICE INCLUDES: - GLASS WITH 1 COLOUR IMPRINT
 - 4 COLOURS OR CRITICAL REGISTRATION CALL FOR QUOTE

DEEP ETCH

ITEM NO.	48	144	288	SET-UP	REPEAT SET-UP
DCH-204	12.6	12.1	11.33	75.00	60.00
DCH-203	13.39	12.85	12.04	75.00	60.00
LCH-103	13.45	12.34	11.3	75.00	60.00
DCH-800	14.82	13.52	12.57	75.00	60.00

2ND LOCATION: ADD\$6.00(C) 5C
 PERSONALIZATION: \$4.50(C)

PRICE INCLUDES: - GLASS WITH 1 DEEP ETCH
 - GIFT BOX AND PAPER WRAP



WINE GLASS Selection



DW834(12OZ/360ML) IMP.AREA: 1.5"H X 2"W
 DW833(16OZ/480ML) IMP.AREA: 1.5"H X 2"W
 DW832(19.25OZ/570ML) IMP.AREA: 1.5"H X 2"W
 DW831(19.25OZ/570ML) IMP.AREA: 1"H X 2"W
 DW825 (10OZ/315ML) IMP.AREA: 1.5"H X 2.25"W WRAP.AROUND: 7.75"W
 DW817 (6.5OZ/195ML) IMP.AREA: 1.25"H X 2"W WRAP.AROUND: 7.75"W
 DW813 (10.5OZ/315ML) IMP.AREA: 1.25"H X 1"W WRAP.AROUND: 7.75"W
 DW816 (7.25OZ/215ML) IMP.AREA: 1.5"H X 2.25"W WRAP.AROUND: 7.75"W
 DW815 (4OZ/120ML) IMP.AREA: 1.25"H X 2"W WRAP.AROUND: 5"W

PRINT

ITEM NO.	72	144	504	1440	SET-UP	REPEAT SET-UP
DW834	6.9	6.41	6.14	6.01	65.00	50.00
DW832	9.2	8.4	7.87	7.61	65.00	50.00
DW831	9.2	8.4	7.87	7.61	65.00	50.00
DW825	8.06	7.38	6.66	6.16	65.00	50.00
DW817	7.01	6.52	6.22	6.03	65.00	50.00
DW813	9.2	8.4	7.87	7.61	65.00	50.00
DW816	7.88	7.48	7.18	6.05	65.00	50.00
DW815	10	9.23	8.87	8.59	65.00	50.00

2ND COLOUR: 0.89(C) 6C

PRICE INCLUDES: - GLASS WITH 1 COLOUR IMPRINT
 - 4 COLOURS OR CRITICAL REGISTRATION CALL FOR QUOTE

DEEP ETCH

ITEM NO.	48	144	288	SET-UP	REPEAT SET-UP
DW834	13.5	13.38	12.03	75.00	60.00
DW832	14.73	14.11	13.19	75.00	60.00
DW831	14.73	14.11	13.19	75.00	60.00
DW825	12.69	11.66	11.11	75.00	60.00
DW817	12.78	12.54	12.13	75.00	60.00
DW813	14.65	13.52	12.57	75.00	60.00
DW816	14.28	13.01	12.14	75.00	60.00
DW815	15.62	14.26	13.25	75.00	60.00

2ND LOCATION: ADD\$6.00(C) 5C
 PERSONALIZATION: \$4.50(C)

PRICE INCLUDES: - GLASS WITH 1 DEEP ETCH
 - GIFT BOX AND PAPER WRAP



BEER MUG Selection

PRINT

ITEM NO.	72	144	504	1440	SET-UP	REPEAT SET-UP
LM203	6.96	6.65	6.41	6.08	65.00	50.00
DM116	7.33	6.9	6.65	6.51	65.00	50.00
DM112	8.56	7.63	7.52	7.26	65.00	50.00
DM144	8.56	7.63	7.52	7.26	65.00	50.00
DM113	8.87	8.74	8.56	8.4	65.00	50.00
LM104	9.26	8.33	8.14	7.92	65.00	50.00
LM007	20.83	19.5	18.04	17.41	65.00	50.00
DM119	9.26	8.33	8.14	7.92	65.00	50.00
DM111	10.01	9.64	9.38	9.08	65.00	50.00
DM202	CALL FOR QUOTE				65.00	50.00

2ND COLOUR: 0.89(C) 6C

PRICE INCLUDES: - GLASS WITH 1 COLOUR IMPRINT
- 4 COLOURS OR CRITICAL REGISTRATION CALL FOR QUOTE

DEEP ETCH

ITEM NO.	48	144	288	SET-UP	REPEAT SET-UP
LM203	13.13	12.48	11.78	75.00	60.00
DM116	15.63	14.26	13.24	75.00	60.00
DM112	17.84	16.29	15.15	75.00	60.00
DM144	17.84	16.29	15.15	75.00	60.00
DM113	18.72	17.07	15.87	75.00	60.00
LM104	16.72	14.7	13.67	75.00	60.00
LM007	30.28	28.83	27.81	75.00	60.00
DM119	16.27	14.7	13.67	75.00	60.00
DM111	16.44	15.17	14.3	75.00	60.00
DM202	13.21	12.54	11.87	75.00	60.00

2ND LOCATION: ADD\$6.00(C) 5C
PERSONALIZATION: \$4.50(C)

PRICE INCLUDES: - GLASS WITH 1 DEEP ETCH
- GIFT BOX AND PAPER WRAP



LM203 (16OZ/480ML) IMP.AREA: 2.25"H X 2.5"W WRAPAROUND: 7"
DM116 (13OZ/390ML) IMP.AREA: 3.25"H X 2.25"W WRAPAROUND: 7"
DM112 (15OZ/444ML) IMP.AREA: 3"H X 2.5"W WRAPAROUND: 7"
DM144(18OZ/540ML) IMP.AREA: 3"H X 2.5"W WRAPAROUND: 8.75"
DM113 (15OZ/444ML) IMP.AREA: 3"H X 2.25"W WRAPAROUND: 7"



LM104(15OZ/444ML) IMP.AREA: 2.5"H X 2.5"W WRAPAROUND: 7.25"
LM007 (33OZ/990ML) IMP.AREA: 2"H X 2.5"W WRAPAROUND: 7.75"
DM119(19.25OZ/569ML) IMP.AREA: 2.75"H X 3"W WRAPAROUND: 7"
DM111 (20OZ/620ML) IMP.AREA: 2"H X 2"W ONE SIDE ONLY
DM202 (16OZ/475ML) DEEP ETCH AREA: 2"H X 2"W DEEP ETCH ONLY

PILSNER Selection

PRINT

ITEM NO.	72	144	504	1440	SET-UP	REPEAT SET-UP
DP809	7.26	6.77	6.63	6.22	65.00	50.00
DP811	8.17	7.09	6.42	5.98	65.00	50.00
DP812	11.06	9.97	9.69	9.4	65.00	50.00
LAB102	6.96	6.28	5.94	5.43	65.00	50.00
DP819	10.02	8.74	8.5	8.01	65.00	50.00
DP826	11.7	11.54	10.8	10.46	65.00	50.00
LP194	10.01	8.99	8.73	8.51	65.00	50.00
DP825	7.45	7.28	6.84	6.61	65.00	50.00
DP824	7.29	7.12	6.68	6.45	65.00	50.00
DP823	7.45	7.28	6.84	6.61	65.00	50.00
DP810	7.45	7.28	6.84	6.61	65.00	50.00

2ND COLOUR: 0.89(C) 6C

PRICE INCLUDES: - GLASS WITH 1 COLOUR IMPRINT
- 4 COLOURS OR CRITICAL REGISTRATION CALL FOR QUOTE

DEEP ETCH

ITEM NO.	48	144	288	SET-UP	REPEAT SET-UP
DP809	13.34	12.68	11.8	75.00	60.00
DP811	13.21	12.07	11.24	75.00	60.00
DP812	18.21	16.84	12.44	75.00	60.00
LAB102	13.05	11.93	11.13	75.00	60.00
DP819	16.69	14.68	13.51	75.00	60.00
DP826	18.46	18.05	16.49	75.00	60.00
LP194	15.91	15.33	13.83	75.00	60.00
DP825	13.31	12.85	12.48	75.00	60.00
DP824	13.21	13.08	12.68	75.00	60.00
DP823	13.38	12.85	12.48	75.00	60.00
DP810	13.69	12.16	11.24	75.00	60.00

2ND LOCATION: ADD\$6.00(C) 5C
PERSONALIZATION: \$4.50(C)

PRICE INCLUDES: - GLASS WITH 1 DEEP ETCH
- GIFT BOX AND PAPER WRAP

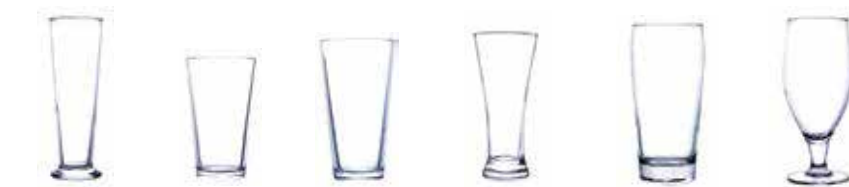

DP809(13OZ/390ML) IMP.AREA: 2"H X 2"W WRAPAROUND: 7.75"
DP811 (16OZ/480ML) IMP.AREA: 3"H X 2"W WRAPAROUND: 7.75"
DP812 (20OZ/620ML) IMP.AREA: 2"H X 2"W WRAPAROUND: 7"
LAB 102(12OZ/355ML) IMP.AREA: 1.5"H X 1.5"W
DP819 (20OZ/620ML) IMP.AREA: 3"H X 2.5"W WRAPAROUND: 7.75"
DP826 (12.75OZ/400ML) IMP.AREA: 2"H X 2.5"W WRAPAROUND: 7.75"



LP194 (16OZ/480ML) IMP.AREA: 1.75" X 2.5"W WRAPAROUND: 7.75"
DP825 (20OZ/600ML) IMP.AREA: 3"H X 2"W
DP824 (20OZ/600ML) IMP.AREA: 2"H X 2"W
DP827 (20OZ/600ML) IMP.AREA: 1.25"H X 1"W
DP823 (23OZ/690ML) IMP.AREA: 2"H X 2"W
DP810 (16OZ/480ML) IMP.AREA: 2"H X 2"W WRAPAROUND: 7.75"



STEMLESS

Selection



DW125 (21OZ/620ML) IMP.AREA: 1"H X 2" W (WHITE WINE)
 DW124 (9OZ/270ML) IMP.AREA: 1"H X 2" W (WHITE WINE)
 DW129 (13.5OZ/399ML) MARTINI



DW126 (16.75OZ/495ML) IMP.AREA: 1"H X 2" W (RED WINE)
 DW127 (17OZ/503ML) IMP.AREA: 1"H X 2" W (WHITE WINE)
 DW131 (8.25OZ/270ML)

PRINT

ITEM NO.	72	144	504	1440	SET-UP	REPEAT SET-UP
DW125	8.82	8.6	8.4	8.12	65.00	50.00
DW124	7.92	7.47	7.17	6.53	65.00	50.00
DW129	CALL FOR QUOTE					
DW126	10.01	8.73	8.49	8.01	65.00	50.00
DW127	10.01	8.73	8.49	8.01	65.00	50.00
DW131	CALL FOR QUOTE					

2ND COLOUR: 0.89(C) 6C

PRICE INCLUDES: - GLASS WITH 1 COLOUR IMPRINT
 - 4 COLOURS OR CRITICAL REGISTRATION CALL FOR QUOTE

DEEP ETCH

ITEM NO.	48	144	288	SET-UP	REPEAT SET-UP
DW125	16.7	15.33	14.78	75.00	60.00
DW124	14.26	13.01	12.28	75.00	60.00
DW129	15.12	14	12.9	75.00	60.00
DW126	16.51	15.27	14.06	75.00	60.00
DW127	16.51	15.27	14.06	75.00	60.00
DW131	13.38	12.84	12.03	75.00	60.00

2ND LOCATION: ADD\$6.00(C) 5C

PERSONALIZATION: \$4.50(C)

PRICE INCLUDES: - GLASS WITH 1 DEEP ETCH
 - GIFT BOX AND PAPER WRAP



SHOOTER

Selection



DS125 (2OZ/59ML) IMP.AREA: 2.5"H X 1.25"W WRAP.AROUND: 4.5"
 DS310 (2.5OZ/75ML) IMP.AREA: 1"H X 1.25"W



DS309 (2.5OZ/75ML) IMP.AREA: 1"H X 1.25"W
 DS307 (2OZ/59ML) IMP.AREA: 1"H X 1.25"W WRAP.AROUND: 5"

PRINT

ITEM NO.	72	144	504	1440	SET-UP	REPEAT SET-UP
DS125	5	4.65	4.39	4.07	65.00	50.00
DS310	5	4.65	4.39	4.07	65.00	50.00
DS309	CALL FOR QUOTE					
DS307	5	4.65	4.39	4.07	65.00	50.00

2ND COLOUR: 0.89(C) 6C

PRICE INCLUDES: - GLASS WITH 1 COLOUR IMPRINT
 - 4 COLOURS OR CRITICAL REGISTRATION CALL FOR QUOTE

DEEP ETCH

ITEM NO.	48	144	288	SET-UP	REPEAT SET-UP
DS125	8.4	8.02	7.42	75.00	60.00
DS310	8.4	8.02	7.42	75.00	60.00
DS309	CALL FOR QUOTE				
DS307	8.4	8.02	7.42	75.00	60.00

2ND LOCATION: ADD\$6.00(C) 5C

PERSONALIZATION: \$4.50(C)

PRICE INCLUDES: - GLASS WITH 1 DEEP ETCH



HIGHBALL OLD FASHIONED Selection



ITEM NO.	72	144	504	1440	SET-UP	REPEAT SET-UP
AH302	6.27	6.14	6.03	5.94	65.00	50.00
AH206	6.9	5.7	5.41	5.31	65.00	50.00
AH204	7.3	6.47	6.0	5.90	65.00	50.00
AH171	6.51	5.79	5.54	5.34	65.00	50.00
DO210	9.12	8.28	8.03	7.88	65.00	50.00
AH209	CALL FOR QUOTE					
AH301	6.27	6.14	6.03	5.94	65.00	50.00
AH107	5.9	5.79	5.54	5.34	65.00	50.00
AO211	7.5	6.47	6.2	6.05	65.00	50.00
LAO207	6.26	5.23	4.97	4.83	65.00	50.00
AH56	15.84	15	14.75	14.6	65.00	50.00
DO136	CALL FOR QUOTE					

2ND COLOUR: 0.89(C) 6C
 PRICE INCLUDES: - GLASS WITH 1 COLOUR IMPRINT
 - 4 COLOURS OR CRITICAL REGISTRATION CALL FOR QUOTE

ITEM NO.	48	144	288	SET-UP	REPEAT SET-UP
AH302	13.44	12.89	10.21	75.00	60.00
AH206	14.21	12.93	10.58	75.00	60.00
AH204	13.58	12.44	12.12	75.00	60.00
AH171	11.12	10.68	8.75	75.00	60.00
DO210	15.27	14.02	12.92	75.00	60.00
AH209	13.58	12.44	12.11	75.00	60.00
AH301	11.12	10.68	8.75	75.00	60.00
AH107	11.12	10.68	8.75	75.00	60.00
AO211	14.41	13.44	12.39	75.00	60.00
LAO207	11.12	10.68	8.75	75.00	60.00
AH56	11.12	10.68	8.75	75.00	60.00
DO136	14.41	13.44	12.39	75.00	60.00

2ND LOCATION: ADD\$6.00(C) 5C
 PERSONALIZATION: \$4.50(C)
 PRICE INCLUDES: - GLASS WITH 1DEEP ETCH
 - GIFT BOX AND PAPER WRAP



COFFEE GLASS Selection

ITEM NO.	72	144	504	1440	SET-UP	REPEAT SET-UP
DC302	6.94	6.24	5.89	5.67	65.00	50.00
*TD2	14.54	13.42	11.18		65.00	50.00
LC130B	8.76	7.93	7.52	7.11	65.00	50.00
DC300	9.22	8.28	8.11	7.98	65.00	50.00
*TD1	17.9	16.78	15.66	14.54	65.00	50.00
LC130	9.02	7.8	7.52	7.28	65.00	50.00
LC131	10.74	10.57	10.38	10.19	65.00	50.00
DC129	8.72	8.28	7.89	7.63	65.00	50.00
DC301	6.99	6.8	6.41	6.2	65.00	50.00
JB262	6.47	6.24	5.89	5.67	65.00	50.00

2ND COLOUR: 0.89(C) 6C
 PRICE INCLUDES: - GLASS WITH 1 COLOUR IMPRINT
 - 4 COLOURS OR CRITICAL REGISTRATION CALL FOR QUOTE
 *TD1 PRICE INCLUDES: - GLASS WITH 1 COLOUR IMPRINT
 - TEA MUG, STAINLESS STEEL INFUSER & GLASS COASTER
 - GIFT BOX

ITEM NO.	48	144	288	SET-UP	REPEAT SET-UP
DC302	13.06	11.97	11.13	75.00	60.00
LC130B	16.47	13.97	13.9	75.00	60.00
DC300	16.1	14.49	13.41	75.00	60.00
LC130	15.34	13.97	13.01	75.00	60.00
LC131	15.59	14.91	14.44	75.00	60.00
DC129	15.66	14.38	13.37	75.00	60.00
DC301	12.54	12.04	11.28	75.00	60.00
JB262	13.06	11.97	11.13	75.00	60.00

2ND LOCATION: ADD\$6.00(C) 5C
 PERSONALIZATION: \$4.50(C)
 PRICE INCLUDES: - GLASS WITH 1DEEP ETCH
 - GIFT BOX AND PAPER WRAP
 *TD2 PRICE INCLUDES: - GLASS WITH 1 COLOUR IMPRINT
 - GLASS TEA MUG WITH HANDLE, SILICONE BAND HEAT GUARD,
 SILICONE TEA BALL INFUSER
 - GIFT BOX



(GIFT BOX)



ELEGANCE SET Selection

DECANTER: (33.75OZ/1000ML)
GLASS: (10.5OZ/315ML)
IMPRINT AREA ON GLASS: 1.5"H X 2.25"W

PRINT

ITEM NO.	50	151	SET-UP	REPEAT SET-UP
ELEGANCE SET	23.02	21.67	75.00	60.00

2ND COLOUR: 1.78(C) 4C
UPDGRADE TO DEEP ETCH LOGO: \$8.40(C)

PRICE INCLUDES:
- 1 DECANTER AND 2 GALSSSES
- 1 COLOUR IMPRINT OR DEEP ETCH ON GLASS
- GIFT BOX

MARTINI GLASS Selection

DEEP ETCH

ITEM NO.	48	144	288	SET-UP	REPEAT SET-UP
DMA803	20.81	19.3	18.42	75.00	60.00
LMA133	12.06	11.34	10.7	75.00	60.00
LMA134	15.02	14.17	13.44	75.00	60.00
LMA135	15.36	14.74	13.79	75.00	60.00

2ND LOCATION: ADD\$6.00(C) 5C
PERSONALIZATION: \$4.50(C)

PRICE INCLUDES: - GLASS WITH 1DEEP ETCH



DMA803(10OZ/296ML)
DEEP ETCH AREA : 0.75"H X 1.25"W



LMA133(9.25OZ/274ML)
DEEP ETCH AREA : 0.75"H X 1.25"W



LMA134(6.75OZ/202ML)
DEEP ETCH AREA : 0.75"H X 1.25"W



LMA135(7.25OZ/217ML)
DEEP ETCH AREA : 0.75"H X 1.25"W



(GIFT BOX)

ELEGANCE DECANTER

PRINTED
(33.75OZ/1000ML)
IMPRINT AREA: 2"H X 2"W

PRINT

ITEM NO.	48	150	SET-UP	REPEAT SET-UP
ELEGANCE DECANTER	14.77	12.3	65.00	50.00

2ND COLOUR: 1.65(C) 4C
UPDGRADE TO DEEP ETCH LOGO: \$4.50(C)
2ND LOCATION: \$6.00(C)
PERSONALIZATION: \$4.50(C)
PRICE INCLUDES: - DECANTER WITH 1 COLOUR IMPRINT
- GIFT BOX



CANDY JAR

Selection



CJB12 (16OZ/480ML)
IMP AREA: 1.75" H X 3" W
WRAPAROUND: 7.75"



CJB2 (15OZ/444ML)
IMP AREA: 1" H X 3" W
WRAPAROUND: 7.75"



CJB14 (27OZ/798ML)
IMP AREA: 1.5" H X 3" W
WRAPAROUND: 7.75"

PRINT

ITEM NO.	72	144	504	1440	SET-UP	REPEAT SET-UP
CJB12	11.09	11.13	9.97	9.7	65.00	50.00
CJB2	11.1	10.69	9.99	9.7	65.00	50.00
CJB14	15.85	14.51	14.11	13.71	65.00	50.00

2ND COLOUR: 0.89(C) 6C

PRICE INCLUDES: - GLASS WITH 1 COLOUR IMPRINT
- 4 COLOURS OR CRITICAL REGISTRATION CALL FOR QUOTE

DEEP ETCH

ITEM NO.	48	144	288	SET-UP	REPEAT SET-UP
CJB12	18.18	16.5	15.3	75.00	60.00
CJB2	18.18	16.5	15.3	75.00	60.00
CJB14	22.32	20.19	18.81	75.00	60.00

2ND LOCATION: ADD \$6.00(C) 5C
PERSONALIZATION: \$4.50(C)

PRICE INCLUDES: - GLASS WITH 1 DEEP ETCH

COASTERS

Selection

PEWTER EMBLEM DECORATION
WM1100
SIZE: 3.5" DIAMETER

PEWTER

ITEM NO.	100	250	500	1000	SET-UP	REPEAT SET-UP
WM1100	16.02	14.91	13.51	12.26	115.00	60.00

PRICE INCLUDES: - ROUND COASTERS 6C
- CHOICE OF FINISH (ANTIQUÉ BRASS OR PEWTER)
- CHOICE OF LEATHER COLOUR (BLACK, BURGUNDY, NAVY, BROWN)
- GIFT BOX INCLUDED



LIGHT ETCHED
TANGO SET
WITH WOODEN BASE
SIZE: 4" DIAMETER
ETCH AREA: 2.75" DIAMETER

ETCH

ITEM NO.	45	SET-UP	REPEAT SET-UP
TANGO SET	19.66	65.00	50.00

PRICE INCLUDES: - 4 GLASS COASTERS 3C
- 1 WOOD STAND
- LIGHT ETCH ON ALL COASTERS
- GIFT BOX INCLUDED

LIGHT ETCHED
SINGLE TANGO COASTER
SIZE: 4" DIAMETER
ETCH AREA: 2.75" DIAMETER

ETCH

ITEM NO.	50	SET-UP	REPEAT SET-UP
TANGO COASTER	7.18	65.00	50.00

PRICE INCLUDES: - LIGHT ETCH 3C
- 1 GLASS COASTER
- GIFT BOX INCLUDED



GIFT BOX

PACKAGING

OPTIONS *Selection*

COMBINE ANY ITEMS FROM OUR CATALOGUE AND
PUT ITEM IN PRESTIGIOUS BELLAGIO PACKAGING



PAPER WRAP INCLUDED

BLACK CRAFT BOX FOR 1
BOX INCLUDED ONLY FOR DEEP ETCH

10" BELLAGIO BOX
\$18.48(C)



VELVET INSERT

19.75" BELLAGIO BOX
\$21.78(C)



GIFT BOX FOR 1
\$3.19(C)

GIFT BOX FOR 2
\$3.74 (C)

(MANY SIZES AVAILABLE)



15"H X 6"W 6.5"H X 5" W 14"H X 5.5"W 10"H X 7"W

SILHOUETTE POUCH \$0.99(C)



HAND CRAFT PILSNER
(FOR 2) FITS DP809 & DP810
\$ 6.49(C)

HAND CRAFT WINE
(FOR 2)
FITS DW834 & DW813 & DW825
\$ 6.49(C)

INDEX

A AH56.....178
 AH107.....178
 AH171.....178
 AH302.....178
 AH204.....178
 AH206.....178
 AH209.....178
 AH301.....178
 AO211.....178
 ASOBU TEA.....116
 AW/2 SET.....171

B BELLAGIO BOX.....185
 BF20.....34-35
 BF30.....32-33
 BL890.....154
 BLACK CRAFT BOX.....184
 BO1.....55
 BO2.....56
 BP01.....150-151
 BTA700.....100
 BTA711S.....89
 BTA712.....88

C CAKE-JC108.....169
 CFM15.....48
 CFM16.....125
 CFM16/MJ.....141
 CJB2.....182
 CJB12.....182
 CJB14.....182
 CMM14.....49
 CS14.....159
 CY2GO.....61
 CUP101.....127

D DC129.....179
 DC300.....179
 DC301.....179
 DC302.....179
 DCH 203.....172
 DCH 204.....172
 DCH 800.....172
 DMA803.....180
 DM111.....174
 DM112.....174
 DM113.....174
 DM116.....174
 DM119.....174
 DM144.....174
 DM202.....174
 DM202-1.....191
 DO136.....176
 DO210.....178
 DP809.....175
 DP810.....175
 DP811.....175
 DP819.....175
 DP823.....175
 DP824.....175
 DP825.....175
 DP826.....175
 DP9812.....175
 DS125.....177
 DS307.....177
 DS309.....177
 DS310.....177
 DWC08.....158
 DW124.....176

DW125.....176
 DW126.....176
 DW127.....176
 DW129.....176
 DW131.....176
 DWG10.....85
 DWG12.....84
 DWG12 T-SET.....119
 DWG77.....79
 DW813.....173
 DW815.....173
 DW816.....173
 DW817.....173
 DW825.....173
 DW831.....173
 DW832.....173
 DW834.....173

E ELEGANCE DECANTER.....181
 ELEGANCE SET.....181
 EPM1/EPM2/EPM3/EPM4.....147
 EPM SET.....110

F FB01.....95
 FB02.....95
 FC2G.....23
 FNG1.....4-7
 FNG2.....8-9
 FP02.....104
 FP03.....105

G G2G.....53
 G4G.....54
 GBD400.....85
 GIFT BOX FOR 1/2.....184-185
 GMF1.....63
 GNT SET.....108

H HAND CRAFT PILSNER.....185
 HAND CRAFT WINE.....185
 HC/MUG440.....135
 HC-PM6 RED.....169
 HT16.....47
 HTG1.....115

I IC17.....45
 ICE56.....170
 IV3G.....75
 IT2GO.....80

J JB262.....179
 JB300.....59
 C1JC07.....168
 JC108.....167
 JC CHALK.....15
 JU2.....91

L LAB102.....175
 LAO207.....178
 LB17.....24-25
 LC130B.....179
 LC17.....36-37
 LC130.....179
 LC131.....179
 LCC16.....46
 LCH 103.....72
 LM007.....174
 LM104.....174
 LM203.....174

LMA133.....180
 LMA134.....180
 LMA135.....180
 LP194.....175
 LX2 TEA.....117

M M168.....163
 M376.....162
 MJ01.....90
 MUG123.....123
 MUG220.....136
 MUG221-224.....112
 MUG330.....138
 MUG330/CH.....139
 MUG440.....134
 MUG550.....146
 MUG590.....160
 MUG770.....148-149
 MUG772.....133
 MUG777.....131
 MUG880.....153
 MUG888.....129
 MUG999.....137

N NG SET.....113

P PARA/888.....143
 PB10.....73
 PB55.....71
 PF01.....97
 PF02.....96
 PM5.....164
 PM6.....166
 PM8.....165

R RS14.....72

S SBV15.....31
 SBV17.....26-29
 SBV19.....14-15
 SBV20.....16-17
 SBV23.....10-11
 SI150.....152
 SI340.....161
 SI7100.....156
 SI900.....155
 SILHOUETTE POUCH.....184
 SINGLE TANGO COASTER.....183
 SNB01.....94
 SNB02.....94
 SNC2.....169
 SO/777.....145
 SPO2.....83
 SPO4.....12-13
 SSB2.....98
 SSB9.....99
 SSB25.....55
 SWG11.....86
 SWG20.....85

T TANGO SET.....183
 TD1.....121
 TD1 T-SET.....118
 TD2.....102
 TD4.....106

TD4 T-SET.....120
 TMF1.....41
 TMF2.....39
 TSB7.....101
 TWB7.....66-67
 TWB8.....64-65
 TWB9.....69
 TWB10.....68
 TWG1.....82

V V2G.....76
 V599.....103
 V600.....40
 V700.....42
 V800.....43
 VIC3.....50
 VIW1.....51
 VOC1.....74
 VPB1.....21
 VT1.....78
 VT13.....77

W WHITE COLLECTION.....18-19
 WHITE ICE.....171
 WM1100.....1183

Y YO2GOS.....93

TERMS AND CONDITIONS

ARTWORK: Artwork should be supplied in electronic format, preferably Vector format (Converted to Curves), Corel Draw file, illustrator or EPS file for PC (not Macintosh). If this cannot be provided the charge incurred for artwork is \$83.00 (C).

The client assumes all liability for accuracy of imprint, imprint colors and placement when approving the art proof.

LOGO POSITIONING: Due to variance in shapes of our products, logo positioning is done using the handle. The lid or spouts may not always be centered. Print location may vary from position on actual paper proof.

IMPRINT ON DARK SURFACES: Colour matching on dark surfaces cannot always be exact.

IMPRINT ON FUNNEL SHAPED DRINKWARE: Logo may have to be modified slightly on these shaped items.

-Four colour process artwork will be subject to further charges if not properly formatted and certain minimums may be necessary to avoid additional costs. We reserve the right to determine these costs prior to production. Exact PMS colour matches are not available. We try to match your colour selection as closely as possible using PMS numbers as a reference only. If a special colour is desired, such a request must be clearly stated and a specimen of the colour to be matched must accompany the order. Special colours may delay your order.

- Gold, Platinum or Purple prints, add \$1.33(C) per side.
 - Due to the nature of ceramic colours, an exact match cannot be guaranteed.

- Due to variance in production equipment, processing inks and other conditions between your original order and reorder, a reasonable variation from the original order to the reorder is considered within acceptable industry standards.

- Wraparound or second side imprints are available at no extra cost on most items if the same colour imprint is used.

- Banding, Acid Wash, Powder Coating, and "Window Effects" are subject to certain minimums and may not be available on certain items. Complex jobs and items not priced or shown available in catalog will be handled on a net price quoting basis.

ARTWORK MODIFICATION: Charge \$25.00(C) when applicable.

LARGE VOLUME QUOTATIONS/SPECIAL PRODUCTS: Large volume pricing can be obtained for all catalog items and many other models upon request. Exclusive technical production and actual products can be produced subject to minimums and other factors.

SAMPLES: Blank or actual fired samples can be provided prior to production. Small runs are subject to net charges for samples at a price of \$75.00 (C). However, on larger runs an actual fired sample may be provided at no charge to sign off on prior to production.

- Any revisions or changes to your original instructions for any speculative samples will incur additional art, screen, and sampling charges, and will revise your scheduled ship date. Due to the variances in production equipment, processing, inks and other conditions between proofing (sampling) and the actual production run, a reasonable variation from the production sample to the production run is considered within industry standards.

GIFT PACKAGING: Custom boxing can be provided, subject to certain minimums and availability, etc... Consult catalog and Customer service for further details.

TRADEMARKS: Any artwork submitted by you or your client will be accepted with the understanding that they are in full compliance with all laws regarding service mark, patent right to privacy and other similar protection. Ad-N-Art disclaims any and all liability for violation to compliance or any laws regarding these matters upon receipt of a purchase order from our clients. Proof of license may be required for copyrighted logos.

OVERRUNS AND UNDER RUNS: We reserve the right to ship up to 5% over or under quantities ordered and invoice accordingly. Orders subject to no overrun may have 5% under runs and vise versa. Decals are subject to 10% over or under runs. On larger orders this will not exceed 2%. Goods broken or lost in transit excluded.

DELIVERY: Normal production is between 5-10 working days of receipt of artwork approval and confirmed purchase order. Large orders, non stock items and busy periods are subject to possible further delays. Contact factory for approval of rush delivery dates or special services.

RUSH SERVICES: Rush services are available on request and are based on the production capabilities of the factory. Consult the Customer service for price quotes and availability options. Rush charge is \$100.00(C) when applicable.

LESS THAN MINIMUM: Charge \$160.00(C)

PRODUCTION TIMES:
 - Printing: 5-7 days
 - Deep etch: 7-10 days
 - Pewter: 3 weeks
 - Decal 3 weeks

INVENTORY AVAILABLE: While every effort is made to maintain all items in inventory, we cannot be held responsible if any item is not available.

SELF PROMOTIONS: -25% off of EQP, + NO sett up charges. Standard minimum qty's applies.

FREIGHT: Please inspect all merchandise upon receipt of goods. Claims for shortages incurred while in transit should be filed with carrier within 10 working days of receipt of order. Title of goods passes to the buyer upon release of merchandise to carrier.

FOB point is our factory in Montreal or regional sales office where applicable.
 -Parcel Shipments - To ensure safe delivery by parcel carriers (Purolator, UPS etc.), on ceramic mugs we offer super pack at \$6.20(G)
 -Ad-N-Art guarantees safe shipment by palletizing and shrink wrapping.

Shipments that are not palletized and shrink wrapped (such as UPS, Fed-Ex, Parcel Post...) are not guaranteed package consolidation.

NOTE: We will not be responsible for any breakages on orders that do not ship on our accounts. Also we will not cover any breakages on all orders of breakable goods of 144 units and over that ship any other way other than by truck.

RETURN POLICY: No goods can be returned without and RA# (Return Authorization Number). A written authorization must be obtained from Customer service. Orders returned without such authorization will not be accepted.

TERMS: Net 30 days from date of invoice for credit approved customers. Accounts must be in good standing in order to constitute credit privileges. Late payments are subject to interest charges. A deposit may be required on large orders prior to production and/or on orders with customers without credit approval.

CANCELLATION CHARGES: Any and all costs incurred prior to an order cancellation will be subject to invoicing.

Artwork can be kept and used at a later date if order is postponed and held for production at a later date
 Set-up: \$50.00 (C)
 Artwork: \$83.00 (C)
 Fired Sample: \$75.00(C)

SIZES & WEIGHTS: All sizes, capacities, dimensions, etching sizes and weights shown in this catalog are approximate

PRE-PRODUCTION PROOFS: If requested, a pre-production proof will be supplied. The proof items will be billed at regular prices, plus set-up charges & shipping. Pre-production proofs may be required by us on large quantity orders. In such cases, these proofs will be provided at no cost.

RANDOM SAMPLES: Random samples will be billed at end column pricing + shipping.

GUARANTEE: Defects in materials and workmanship will be corrected without charge. However, please be aware that even in the finest crystal, minor variations in clarity can occur. Occasional air bubbles, chill marks, or flow lines are inevitable. Such minor variations are not considered defects. We reserve the right to inspect items from the actual production run before processing any complaints or disputes.

SHIPPING:
 - Drop shipments: \$10.00(C) / after first address up to 10 locations.
 if more than 10 locations: \$25(C)/ location
 - Tailgate for truck (if required): \$160.00(C)
 (will be added on 2nd invoice if we are not notified prior to shipping)
 - Truck delivery to residential address: \$160(C)
 (will be added on 2nd invoice if we are not notified prior to shipping)
 - Wooden pallet: \$11.50(C)
 * The client also assumes all costs if delivery is expedited in any way

Ad-N-Art Inc reserves the right to update pricing during the course of the year. Official and current pricing can be found at www.adnart.com

WHAT IS CRITICAL REGISTRATION ?
NOT CRITICAL **CRITICAL**



DRINK DIFFERENTLY

DRINK DIFFERENTLY

WWW.ADNART.COM

